

# Eco—i Manual

Agri-food Supplement



Copyright © United Nations Environment Programme 2017

This publication may be reproduced in whole or in part and in any form for educational or non-profit purposes without special permission from the copyright holder, provided acknowledgement of the source is made. UN Environment would appreciate receiving a copy of any publication that uses this publication as a source.

No use of this publication may be made for resale or for any other commercial purpose whatsoever without prior permission in writing from the United Nations Environment Programme.

### **Disclaimer**

The designations employed and the presentation of the material in this publication do not imply the expression of any opinion whatsoever on the part of the United Nations Environment Programme concerning the legal status of any country, territory, city or area or of its authorities, or concerning delimitation of its frontiers or boundaries. Moreover, the views expressed do not necessarily represent the decision or the stated policy of the United Nations Environment Programme, nor does citing of trade names or commercial processes constitute endorsement.

ISBN: 978-92-807-3636-6

UN Environment promotes environmentally sound practices globally and in its own activities. This publication is printed on 100% recycled paper, using vegetable -based inks and other eco-friendly practices. Our distribution policy aims to reduce UN Environment's carbon footprint.

# Eco—i Manual

## Agri-food Supplement



### **UN ENVIRONMENT ECONOMY DIVISION**

**Sustainable Lifestyles, Cities and Industry Branch**

1 rue Miollis  
Building VII  
75015 Paris  
Tel: +33 1 44371450  
Fax: +33 1 44371474  
E-mail: [economydivision@unep.org](mailto:economydivision@unep.org)  
Internet: [www.unep.org](http://www.unep.org)



### **TECHNICAL UNIVERSITY OF DENMARK**

**Department of Mechanical Engineering  
Engineering Design and Product Development**

Nils Koppels Allé Building 404  
DK- 2800 Kgs. Lyngby  
Tel (+45) 45 25 19 60  
Fax: (+45) 45 25 19 61  
E-mail: [info@mek.dtu.dk](mailto:info@mek.dtu.dk)  
<http://www.mek.dtu.dk/>

# About the UN Environment Economy Division

The UN Environment Economy Division helps governments, local authorities and decision-makers in business and industry to develop and implement policies and practices focusing on sustainable development.

The Division works to promote:

- sustainable consumption and production,
- the efficient use of renewable energy,
- adequate management of chemicals,
- the integration of environmental costs in development policies.

The Office of the Director, located in Paris, coordinates activities through:

- The International Environmental Technology Centre - IETC (Osaka, Shiga), which implements integrated waste, water and disaster management programmes, focusing in particular on Asia.
- Production and Consumption (Paris), which promotes sustainable consumption and production patterns as a contribution to human development through global markets.
- Chemicals (Geneva), which catalyzes global actions to bring about the sound management of chemicals and the improvement of chemical safety worldwide.
- Energy (Paris), which fosters energy and transport policies for sustainable development and encourages investment in renewable energy and energy efficiency.
- OzonAction (Paris), which supports the phase-out of ozone depleting substances in developing countries and countries with economies in transition to ensure implementation of the Montreal Protocol.
- Economics and Trade (Geneva), which helps countries to integrate

environmental considerations into economic and trade policies, and works with the finance sector to incorporate sustainable development policies.

UN Environment Economy Division activities focus on raising awareness, improving the transfer of knowledge and information, fostering technological cooperation and partnerships, and implementing international conventions and agreements.

For more information see [www.unep.org](http://www.unep.org)

# Acknowledgements

The sector specific supplement for agri-foods value chains, as an integral part of the Eco-innovation Manual, has been commissioned by the United Nations Environment Programme (UN Environment) and is the result of close collaboration with the Technical Research Institute of Sweden (SP)

Lead author: Haris Hondo.

Supervision and coordination at UN Environment, Economy Division: Liazzat Rabbiosi, Katie Tuck, Andrea Floudiotis, Elisa Tonda, Joni Pegram, and Garrette Clark.

The working version of sector specific supplement for agri-foods value chains was tested during the implementation of the Eco-innovation Project by project teams of Centre for Creativity and Sustainability in Vietnam, National Cleaner Production Centre Sri Lanka, and Uganda Cleaner Production Centre. UN Environment is grateful for their committed work in testing and applying the eco-innovation manual's methodology and sector specific supplement with small and medium enterprises in agri-foods value chains in their respective countries and for their invaluable feedback from this experience.

UN Environment acknowledges the following people that provided comments to the preparatory work for the conceptual and methodological formulation of the sector specific supplement for agri-foods value chains: Calestous Juma, Robert Jack Pagan, Richard Swanell, James Lomax, Clementine O'Connor, Joyce Chitja, Roberto Azofeifa, Chikumbi Chungu, Samir Jouini, Adriana Alzate, Nguyen Hong Long, Santiago Madriñán, Alejandro Boada, Liliana Montenegro, Tatiana Botelho, Puji Lestari.

In addition, UN Environment acknowledges the valuable contribution made by the following people: Faycal Boureima, Kevin Ramirez, Jamie O'Hare, Karina Boers and Helena Rey.

Special thanks also go to the participants of the Regional validation and training workshops in five global regions of Asia Pacific, Africa, Latin America and the Caribbean, Europe and West Asia. Too numerous to mention, their inputs and provision of comments have also significantly helped to tailor this supplement to the needs of the end user.

UN Environment gratefully acknowledges the funding support of the European Commission to the Eco-innovation Project and related activities.

Design was led by Mercè Rua and Adrià Garcia i Mateu from HOLON.

# Table of contents

ACTIVITIES WITH SUPPLEMENTARY CONTENT	<b>7</b>
<b>PHASE 1 - PREPARE</b>	<b>11</b>
<b>PHASE 2 - SET STRATEGY</b>	<b>53</b>
<b>PHASE 3 - SET BUSINESS MODEL</b>	<b>89</b>
<b>PHASE 4 - BUILD ROADMAP</b>	<b>145</b>
<b>PHASE 5 - IMPLEMENT</b>	<b>157</b>
GLOSSARY OF KEY TERMS	<b>162</b>
LIST OF FIGURES, TABLES AND INDUSTRY EXAMPLES	<b>164</b>

# Activities with supplementary content

## PREPARE

---

Identify the right market for the eco-innovation services

Evaluate potential markets  
**PR.1**

---

Build the right team to deliver the service

Build the right internal team  
**PR.2**

Build the right external partnerships  
**PR.3**

*\*Activities not covered in the supplement are faded*

Understand the value chain sustainability hotspots, opportunities and threats

Identify sustainability hotspots across the value chain  
**PR.4**

Identify the general opportunities and threats across the value chain  
**PR.5**

---

Develop a concept for a more sustainable value chain

Develop a value chain vision  
**PR.6**

Engage potential clients

Develop a value chain pitch  
**PR.7**

Plan and implement engagement activities  
**PR.8**

---

Gain approval from senior management to proceed

Pitch the benefits of eco-innovation to the CEO  
**PR.9**

## SET STRATEGY

---

Get ready for the Preliminary Assessment

Plan my data gathering strategy  
**ST.1**

---

Understand the current business strategy

Interview the CEO  
**ST.2**

---

Understand the current business model

Capture the current business model  
**ST.3**

---

Understand the current operational performance

Do a Walk-Through Audit  
**ST.4**

Do a workshop/ interviews with staff  
**ST.5**

Update the sustainability hotspots  
**ST.6**

---

Analyse the information I have gathered

Do a SWOT analysis  
**ST.7**

---

Define the company vision and strategic goals of the new business strategy

Develop a vision for the company  
**ST.8**

Define the strategic goals  
**ST.9**

# Activities with supplementary content

## SET BUSINESS MODEL

---

Define the products, markets and selling points of the new business strategy

Generate ideas for new products, markets and selling points  
**ST.10**

Evaluate ideas for new markets, products and selling points  
**ST.11**

Select which ideas for new markets, products and selling points to include in the strategy proposal  
**ST.12**

---

Get senior management approval for the new business strategy

Do an individual/group review of the business strategy proposal  
**ST.13**

Pitch the new business strategy to the CEO  
**ST.14**

Consider key management issues for implementation  
**ST.15**

---

Understand in more detail the performance of the company through an In-Depth Assessment

Update the data gathering strategy  
**BM.1**

Gather additional data on the business model  
**BM.2**

Gather additional data on operational performance  
**BM.3**

---

Generating business model concepts at the big picture level

Generate business model concepts at the big picture level  
**BM.4**

---

Generating ideas at the individual building block level

Generate ideas for the customer segments block  
**BM.5**

Generate marketing ideas for the value proposition block  
**BM.6**

Generate technical ideas for the value proposition block  
**BM.7**

Generate ideas for the channels block  
**BM.8**

Generate ideas for the customer relationships block  
**BM.9**

Generate ideas for the revenue streams block  
**BM.10**

Generate ideas for the key resources block  
**BM.11**

Generate ideas for the key activities block  
**BM.12**

Generate ideas for the key partnerships block  
**BM.13**

Generate ideas for the cost structure block  
**BM.14**



# Activities with supplementary content

## BUILD ROADMAP

---

Evaluate the business model concepts and select one to pitch

Evaluate the benefits  
**BM.15**

Evaluate the costs  
**BM.16**

Evaluate the risks  
**BM.17**

Integrate all the evaluations and make the final selection  
**BM.18**

---

Get senior management approval for the new business model

Pitch the new business model to the CEO  
**BM.19**

Build a roadmap for eco-innovation implementation

Prepare for the roadmapping workshop  
**BR.1**

Do a roadmapping workshop with input from value chain partners  
**BR.2**

Define and prioritise the requirements of the first project  
**BR.3**

Get senior management approval for the implementation roadmap

Pitch the implementation roadmap to the CEO  
**BR.4**

## IMPLEMENT

Create a project plan and get it approved

Create a project plan  
**IM.1**

Present the project plan to the Senior Management Team  
**IM.2**

---

Support the implementation activities

Provide guidance and solve problems  
**IM.3**

## REVIEW

Review the performance of the first project for eco-innovation

Do a project review workshop  
**RE.1**

Do a personal review  
**RE.2**

---

Review the business model and roadmap and agree the next steps

Review the business model and roadmap  
**RE.3**

Present the review conclusions and agree next steps with the CEO  
**RE.4**



# PREPARE

Prepare to engage a company and its value chain  
and build the potential company's interest  
in the rewards available from eco-innovation



# PR.1

Evaluate  
potential markets



# PR.1 Evaluate potential markets

## TIPS & TRICKS

### ADDITIONAL CONSIDERATIONS FOR AGRIFOOD MARKETS

You can filter your list of high-economic value, agri-food markets further by considering the following questions:

- What are the most relevant market trends? (e.g. convenience products, healthy foods or fresh food distribution)
- Do relevant national or regional policies and roadmaps exist that promote or hinder some activities? (e.g. support to export a given product, stricter compliance criteria for export)
- Which voluntary initiatives apply to the chosen market?
- Do legal regulations exist that influence

your business (e.g. restrictions on the use of palm oil or trans fat)?

- What unmet needs can you identify from market trends (e.g. calorific or nutrient value in current products)?
- Which end markets are most attractive from a value proposition perspective?
- Which agri-food companies serve the end market, and where are they located in the value chain?
- Which steps in the value chain create the most value?

Based on this, you can start thinking about:

- What key capabilities can agri-food companies offer in these markets to achieve a competitive advantage?

How can these key capabilities be translated into a new business strategy and business model?

### LOOK FOR MARKETS WITH HIGH ECONOMIC VALUE

You may start by identifying the agri-food markets that have higher economic value in your region (e.g. bakery, meat products, fruits & vegetables and fish) and analyse the value chains of these sectors from raw material production to how the final products are sold to and consumed by the consumer or end-user. This will help to identify the main players in the value chain (e.g. farmers, food industry and retailers) and the markets with potential for eco-innovation.

### USE OF BENCHMARKS TO IDENTIFY AGRIFOOD MARKETS WITH HIGH POTENTIAL FOR IMPROVEMENT

Benchmarking is a technique used to assess performance against either internal or industry standards. Operational or technological improvement measures first applied at one site may be applicable at others, even in different food and drink processing markets. These techniques may be considered in addition to comparing numerical consumption and emission levels. Typically, benchmarks are expressed as ratios, but can also be expressed as percentages, e.g. efficiency. More information on benchmarking provided in activity BM.3 Gather additional data on operational performance.

# PR.1 Evaluate potential markets

## IDENTIFY INNOVATIVE MARKETS

The implementation of eco-innovation might be more successful in a market that is more open to innovation in general. For instance, the meat industry in many countries is considered conservative and very reluctant to any changes. By comparison, the dairy industry has seen a lot of innovation, especially regarding new product development. Within a given industry the level of innovation will also vary depending on the local context. In order to identify innovative markets you can:

- Use your personal experience – as a consumer of food products, what trends have you noticed on the food shelves at your local market? From

which industry do you see new innovative products? Is there a particular industry that has increased focus on sustainability?

- Conduct desk research – search for companies/products that are being recognized as innovative in your region. What markets do these companies serve?
- Interview key people from the industry – this might give you a good insight into how innovative companies are in different markets. Try to understand why they are innovating. Is it to meet consumer demands, legislative pressures, or some other reason?

## LEARNING CASE STUDY

At this stage you have selected to focus on the food and drink processing sector from the list of key industrial sectors in the country that were identified by completing Section A in the *Target Identification* template. After conducting additional market research and completing section B, you have selected the processed fruit and vegetables market to target with your eco-innovation services. Although this market does not have as high environmental impact as the meat, dairy or fish markets, it has a high potential for improvement due to the large amount of waste generated across all stages in the value chain. This is also a market with a high social impact. The market growth is stable and there is a significant potential for companies to enter new markets. You have also learned that the fruits and vegetables processing market is a high priority within the National Development Plan. The Plan suggests several measures to strengthen and support the fruit and vegetables processing sector with the aim of increasing exports of 'value-added products' rather than raw produce. Several companies serving the processed fruits and vegetables market showed potential for eco-innovation, obtaining high scores in Section C of the *Target Identification* template.

# PR.1 Evaluate potential markets

## BACKGROUND INFORMATION

### Overview the agri-food value chain

To support Service Providers (SPs) in identifying markets and companies suitable for eco-innovation, this section will provide an overview of the structure of the agri-food sector and its subsectors (shown in Figure 1), as well as the agri-food value chain.

The agri-food sector consists of two major parts:

- **Primary production** consists of all activities at the farming level and is responsible for producing raw materials for the processing industry or fresh products that are sold on the consumer market.
- **Agro-industry** is defined as activities beyond the farm gate. These activities often include transforming food raw materials from primary production into value added food products.

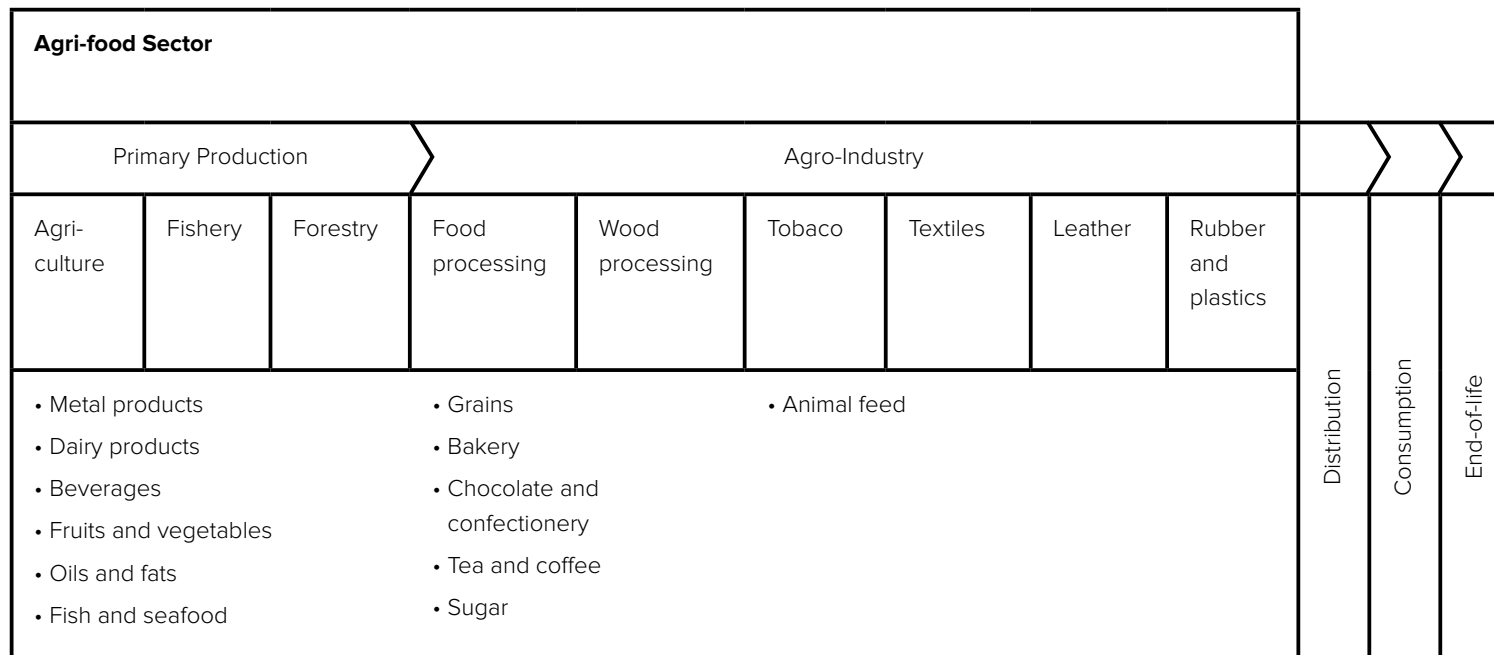

Figure 1. Overview of the agri-food sector structure



# PR.1 Evaluate potential markets

A simplified schematic representation of a typical agri-food value chain can be seen in Figure 2 with a short explanation below.

- **Raw material Production** - includes all on-farm agricultural activities as well as fishing and hunting.
- **Storage and handling** - a transition phase, for example when the crops are stored after being harvested or transportation of animals ready for slaughter. The phase ends when raw material reaches the food manufacturing facility or food distributor in the case of selling fresh agricultural products. Activities in this phase may include washing, cold storage and packaging.
- **Processing and packaging** - in this phase the raw materials are transformed into a finished product (ready to eat or ready-to cook), through food processing operations.
- **Distribution and market** - in this phase the product from the food processing facility is transported and distributed to reach the end consumer. Retailers, wholesalers, and restaurants are actors in this phase of the food value chain. Particularly important to mention is the increasing influence of the retail sector on the whole agri-food sector.
- **Consumption** - when the food products reach the consumer, some are consumed in their present form (ready to eat), while other are prepared according to specific culinary practices. This includes all the home cooking processes, such as boiling, frying or grilling.
- **End-of-life** – this phase is concerned with the disposal of agri-food products that are not/not entirely consumed, as well as disposal of the packaging materials. Typical end of life solutions for the agri-food sector include: reuse, recycle, composting, incineration, fermentation, and landfill.



Figure 2. Generic food value chain

# PR.1 Evaluate potential markets

Figure 3 shows a detailed agri-food value chain including the flows of all important inputs and outputs. This is still a general representation, as different markets will have different value chains.

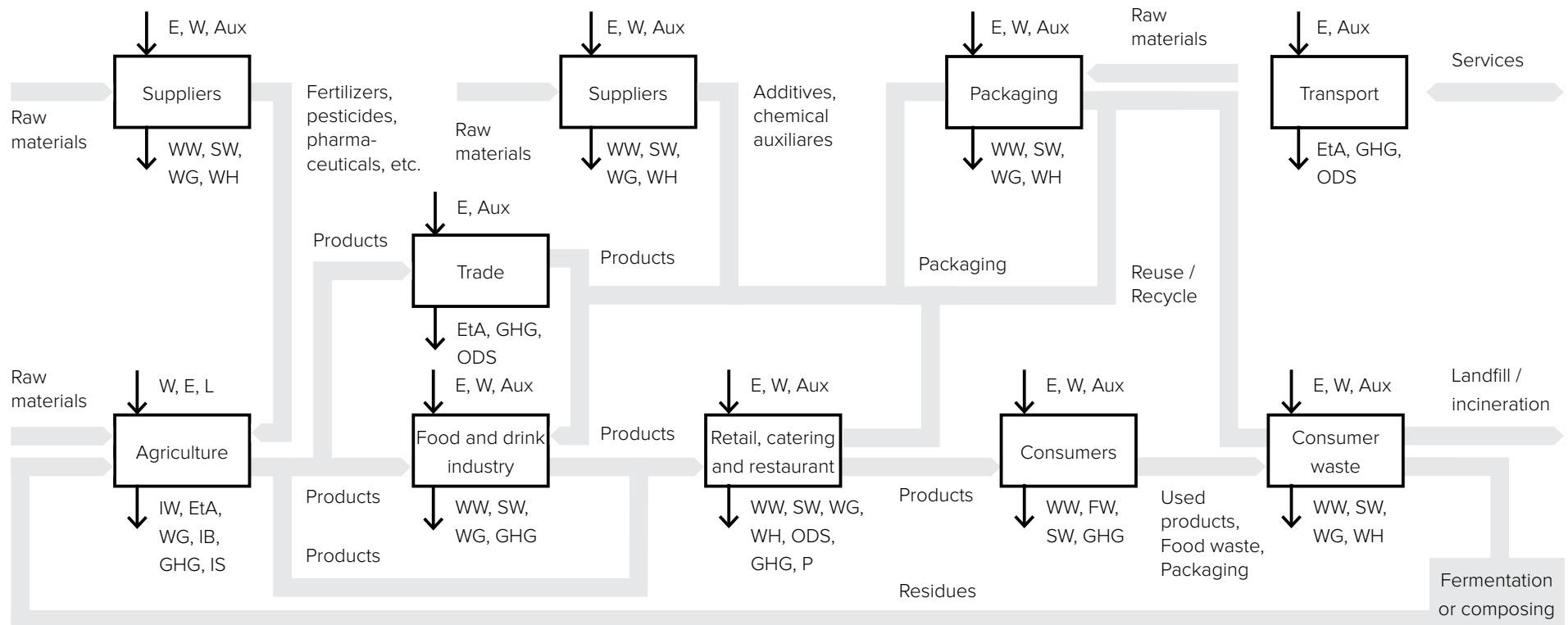

**Legend**

<u>Inputs:</u> E: Energy	Aux: Auxiliaries	<u>Outputs:</u> WW: Waste water	P: Packaging materials	IW: Impact on water	IB: Impact on biodiversity
W: Water	L: Land	WH: Waste heat	ODS: Ozone Depleting Substances	SW: Solid waste	FW: Food waste
		IS: Impact on soil	WG: Waste Gas (diffuse emissions)	EtA: Emissions to air	EtA: Green House Gases

# PR.1 Evaluate potential markets

## Sustainability hotspots in agri-food markets

Figure 4. ranks some agri-food markets according to greenhouse gas emissions. This figure is a useful representation of the overall environmental impact of different markets. It is worth noting that meat products have an extremely high impact compared to products based on vegetables or grains.

## Understanding the food and drink processing industry

The food and drink processing industry (also referred as the 'food and drink manufacturing industry', or simply 'food industry') is a diverse and complex sector. There are many possibilities for eco-innovation in the food and drink processing industry as well as a number of

challenges ranging from a lack of financial and human resources, changing consumer demands and concerns about implementation of new regulations related to health and safety, the environment, labour, etc. (Leis et.al., 2011).

Unlike other products, foods and drinks are ingested which places strict requirements on health and safety. Additionally, attributes like taste, consistency, and olfactory properties play a role along with ethical, religious and psychosocial aspects. The food and drink processing industry is strongly connected with down- and upstream value chain actors like agriculture, life sciences, packaging companies, distribution and retail, each of which can also play an important role in eco-innovation activities.

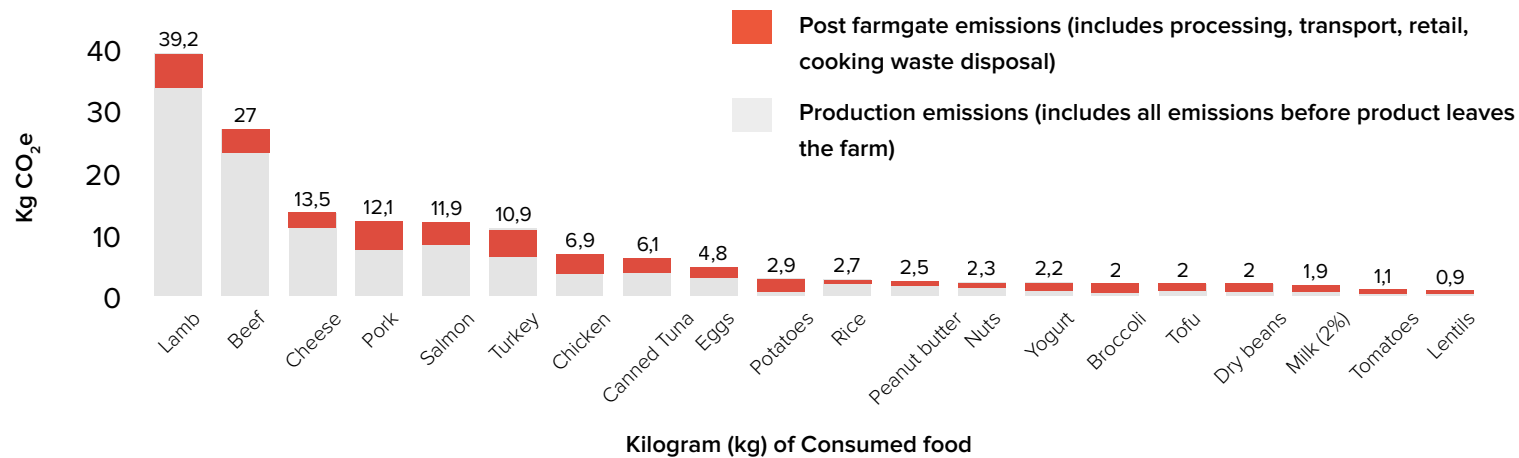

Figure 4. Greenhouse gas emission from selected food products (Environmental Working Group, 2011)

# PR.1 Evaluate potential markets

The industrial sector of food and drink processing is seen as mid-to-low tech (Hirsch-Kreinsen, 2006). The product palette from the industry ranges from niche and traditional specialty products to highly innovative and modified ones like convenience and functional foods and drinks. Also the customer preferences for foods and drinks spans a very wide range from fast food to slow food, from vegan to meat specialties, and from innovative organic drinks to traditional craft beer. In general, there is a clear distinction between innovative food and drink companies and traditional ones that put more emphasis on continuity rather than on innovation and change (CIAA, 2006a). This is especially apparent in several food markets (rather than drink markets) which are characterised by highly innovative and research-intensive activities (e.g. functional and novel foods) on the one hand and many traditional manufacturing methods and products that in some cases cannot be changed if the manufacturer wants to use certain labels and names (Leis et.al., 2011).

Food and drink processing, including packaging, can be defined as the activities of transforming highly perishable raw materials into, often long-lasting, food products. Typically food and drink processing uses harvested crops or butchered animal products from agricultural activities to manufacture an attractive, marketable product. The reasons for processing foods are summarized in table 1.

Table 1. Reasons why food processed and its intended benefits (Adapted from Teaching the Food System, n.d.)

Reason for food being processed	Intended benefit of food processing	Examples of processes and foods	Advantages for food processing companies
<b>Preservation</b>	Increases shelf-life and availability	<ul style="list-style-type: none"> <li>• Pasteurization of milk or juices</li> <li>• Fermenting dairy into cheese or yogurt</li> <li>• Pickling or canning produce</li> <li>• Curing meats</li> </ul>	<ul style="list-style-type: none"> <li>• Products can be transported over longer distances</li> <li>• Products could be stocked during high season and sold in off season</li> <li>• Meet consumer demands for long shelf-life products</li> <li>• Decrease waste</li> </ul>
<b>Increase food safety</b>	Removes, destroys or inhibits pathogens and toxins	<ul style="list-style-type: none"> <li>• Washing, pasteurizing, cooking, salting, drying, refrigeration, freezing</li> </ul>	<ul style="list-style-type: none"> <li>• Decreases risk for foodborne illness outbreaks</li> </ul>
<b>Convenience</b>	Reduces preparation times and makes food more portable	<ul style="list-style-type: none"> <li>• Ready-to-eat meals,</li> </ul>	<ul style="list-style-type: none"> <li>• May lead to higher profits by responding to consumer demand for convenience food</li> </ul>
<b>Increase variety</b>	Change of flavour, texture colour or shape	<ul style="list-style-type: none"> <li>• Milling grains</li> <li>• Mixing ingredients</li> <li>• Adding flavours, colours and fortifications</li> <li>• Moulding foods and ingredients into shapes</li> </ul>	<ul style="list-style-type: none"> <li>• Increased profits through products differentiation</li> <li>• Wider market access</li> </ul>
<b>Nutrition</b>	Restoration or raise nutrient levels in food	<ul style="list-style-type: none"> <li>• Fortification of milk with vitamin D, salt with iodine and grains with B vitamins, iron and folic acid</li> </ul>	<ul style="list-style-type: none"> <li>• Can be used as a unique selling point</li> </ul>

# PR.1 Evaluate potential markets

## References

European Food SCP Round Table (2012). Continuous Environmental Improvements Available from: [http://www.food-scp.eu/files/Continuous\\_Environmental\\_Improvement\\_FINAL\\_21\\_November\\_2012.pdf](http://www.food-scp.eu/files/Continuous_Environmental_Improvement_FINAL_21_November_2012.pdf)

Environmental Working Group (2011). Meat Easter Guide: Methodology 2011 Available from: [http://static.ewg.org/reports/2011/meateaters/pdf/methodology\\_ewg\\_meat\\_eaters\\_guide\\_to\\_health\\_and\\_climate\\_2011.pdf?\\_ga=1.9397493.1766395113.1470748927](http://static.ewg.org/reports/2011/meateaters/pdf/methodology_ewg_meat_eaters_guide_to_health_and_climate_2011.pdf?_ga=1.9397493.1766395113.1470748927)

Leis, M., Gijsbers G., van der Zee,F. (2011). Sectoral Innovation Watch – Food and Drinks Sector, Final Sector Report, Europe INNOVA Sectoral Innovation Watch, for DG Enterprise and Industry, European Commission Available from: [http://www.praxis.ee/wp-content/uploads/2014/03/sector-report-food\\_en.pdf](http://www.praxis.ee/wp-content/uploads/2014/03/sector-report-food_en.pdf)

Hirsch-Kreinsen, H. (2006). 'Low-tech' Industries: Innovativeness and Development

CIAA (2006a) Vision Paper. Ten theses on food and drink SMEs and innovation in Europe: evidence on needs and policy recommendations Available from: <http://smes-net.ciaa.eu/asp/home.asp>

Teaching the Food System (n.d.). A Project of the Johns Hopkins Center for a Livable Future Available from: <http://www.jhsph.edu/research/centers-and-institutes/teaching-the-food-system/curriculum/index.html>



## PR.3

Build the  
right external  
partnerships



## PR.3 Build the right external partnerships

### TIPS & TRICKS

#### CONSIDER FINDING ADDITIONAL FINANCES FOR YOUR ECO-INNOVATION ACTIVITIES

There are several funding schemes that could be utilised for conducting eco-innovation activities at SMEs in developing countries.

Some common financial partners in the agri-food value chain might include:

- Government organisations and ministries (for example in fields of commerce, energy, agriculture, development, industry)
- International organisation (UN Environment, UNIDO, USAID, FAO)
- NGOs
- Financial institutions
- Private foundations

Some specific financing schemes available for SMEs in developing countries are presented in table 2.

Table 2. List of examples of funding schemes available for eco-innovative SMEs (UNIDO, 2009)

Funding schemes utilized by NCPCs	Other funding schemes from financial institutions	Information networks and tools
<ul style="list-style-type: none"> <li>• Bolivia: Biomass and Cleaner Production Fund</li> <li>• Brazilian Micro and Small Business Support Service</li> <li>• SEBRAE and ABN AMRO funding</li> <li>• Colombia: Linea de Credito Ambiental LCA; Green Credit Line of SECO</li> <li>• El Salvador – Industrial/Environmental line by BMI and KfW</li> <li>• Morocco – KfW Green Fund FODEP</li> <li>• Peru – Green credit Trust of SECO</li> <li>• Russian Federation: NEFCO's financial mechanism for North Western Russia</li> <li>• Sri Lanka: SMED; SMILE; E-FRIENDS and PEP</li> <li>• Uruguay: Credit line to support cleaner production</li> </ul>	<ul style="list-style-type: none"> <li>• Asian Development Bank (ADB)</li> <li>• African Development Bank (AfDB)</li> <li>• Austrian Development Corporation (ADC)</li> <li>• Autrian Kommunkredit (AG)</li> <li>• Corporacion Andina de Fomento (CAF)</li> <li>• Developing World Markets</li> <li>• European Fund for South-East Europe (EFSE)</li> <li>• FORTIS investments</li> <li>• German KfW and DEG</li> <li>• German Microfinance Institute (DMI)</li> <li>• GTZ – Mercosur</li> <li>• International Finance Corporation (IFC)</li> <li>• Multilateral Investment fund (MIF) of the Inter-American Development Bank (IDB)</li> <li>• Netherlands Green Funds Scheme</li> <li>• Nordic Environment Finance Corporation (NEFCO)</li> <li>• USAID</li> </ul>	<ul style="list-style-type: none"> <li>• UN Environment Financial Institutions Initiative on the Environment</li> <li>• UNIDO Investment Promotion Agencies (IPAs), Investment in Technology Promotion Offices (ITPOs) and Investment Promotion Units (IPUs)</li> <li>• Africa Investment Promotion Agency (AfrIPANet)</li> <li>• Asia-Africa Investment and Technology Promotion Centre (AAITPC)</li> <li>• Sustainable Alternatives Network (SANet)</li> <li>• UN Environment Sustainable Energy Finance Initiative (SEFI)</li> <li>• UNIDO COMFAR Tool for Investment Appraisal</li> </ul>



## PR.3 Build the right external partnerships

### **BUILD PARTNERSHIPS BETWEEN SMES WITH SIMILAR NEEDS**

Clustering SMEs with similar needs can lead to a synergy between companies benefiting all parties involved. Your role as a service provider can be to facilitate meetings and discussions about opportunities for cooperation between SMEs. This can be done for instance by building networks and organizing events (social media can be used as a powerful tool to help with this). Companies working together can share costs for procurement, distribution, R&D, marketing and work towards a larger goal that would be unachievable for any individual company. This is particularly important for start-ups and small companies in the food and drink processing industry who lack funds and knowledge in order to grow.

### **IDENTIFYING MOST IMPORTANT VALUE CHAIN ACTORS**

The *Life Cycle Stakeholder* template will help you identify value chain stakeholders in your target market. Try to identify the key companies and organisation from each part of the value chain. Focus on understanding how the value chain stakeholders are communicating and which companies have the most bargaining power. A company with high bargaining power can have more influence on other value chain stakeholders and more business opportunities, which can be useful in future eco-innovation activities. Prominent value chain stakeholders might have already started to incorporate sustainability into their operations, which might make them more willing to engage in eco-innovation.

## **LEARNING CASE STUDY OF LIFE CYCLE STAKEHOLDERS**

### **Life Cycle Stakeholders**

Contacting and engaging the potential partners to contribute to eco-innovation activities at the company can help your position and arguments when pitching to the CEO later in the PREPARE phase. A general value chain for the processed fruit and vegetable market was used. From this, four key stakeholders were identified, namely: farmers, research and development partners, financial institutions and local government.

### **Farmers**

Procurement of sustainably grown fruits and vegetables is a requirement for entering new markets for sustainable food products. In this regard, farmers will be key partners in providing the necessary raw materials.

**Research and development partners** such as technical research institutes/universities

Many companies lack the skills and resources required for conducting research and development based innovation projects on their own. External help will be needed to face some challenges and to seize opportunities when they arise. The research partners can assist in various eco-innovation projects such as:

- Conduct a Life Cycle Assessment to quantify the environmental and social impacts in the product value chain
- Assess and improve food safety management
- Support the development of farming and processing inputs - such as seeding material, fertilizers and processing aids - in order to increase the production and processing yields
- Support the development of new fruit and vegetable products

# PR.3 Build the right external partnerships

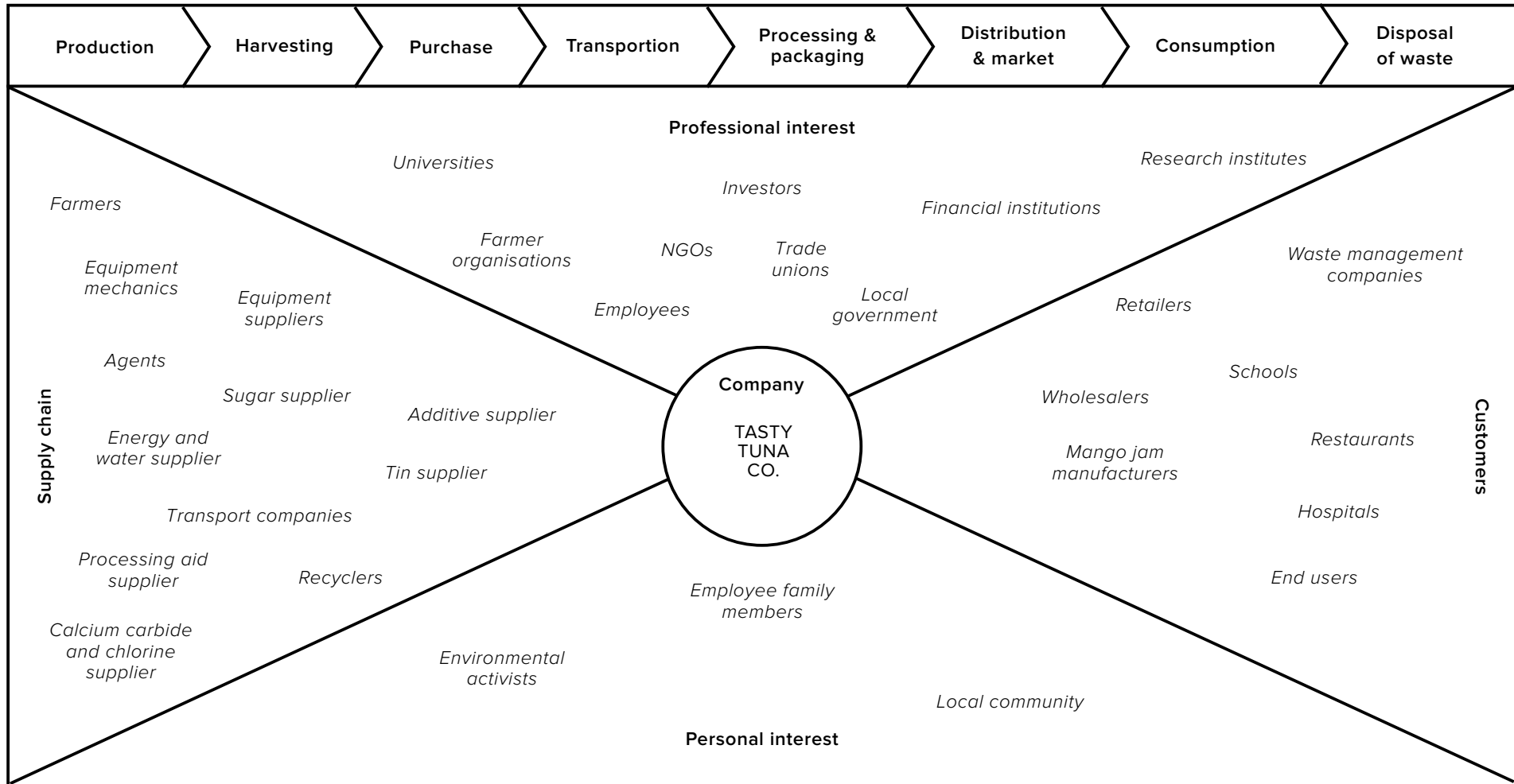

## PR.3 Build the right external partnerships

- Support the development of new packaging materials
- Conduct market research
- Find alternative solutions for the processing of fruits and vegetables

### Financial institutions

Faced with cash flow limitations, fruits and vegetables processors might need financial help to conduct certain of their eco-innovation activities, such as developing new products or entering new markets. Financial institutions could support the eco-innovation activities by providing the funding needed.

### Local government

A policy framework that is beneficial to SMEs that are willing to decrease their environmental and social impact while increasing their exports could further support eco-innovation activities. For instance, the local government might create a task force working focused in implementing the National Development Plan by supporting the growth of local SMEs. The help might be in the form of direct funding or by providing expert support to help companies place their products on the export market.

## BACKGROUND INFORMATION

### Common partnerships in the agri-food value chain

The agri-food value chain is shifting from being predominantly supply-driven to demand-driven. A demand-driven market requires more planning and collaboration along the value chain with partners such as suppliers of raw materials and utilities, transportation companies and distributors. It is important to be flexible and responsive to the fast changing consumer preferences but also to continuously anticipate future trends.

The change to a more demand-driven market has moved the bargaining power downstream in the supply chain, towards retailers in particular. By collaborating with the retailers, the manufacturers can get more insight into the store's inventory, future plans and forecast. This can help the manufacturers to identify and respond to customer demand but also help the retailers to keep minimum levels of inventory. Such collaboration will benefit both parties and can reduce unnecessary transportation, storage and waste of unsold or expired products (Berndt, 2006).

Below are some examples of partnerships in the agri-food value chain, the partnerships are covered in more detail in the activity BM.13 Generate ideas for the key partnerships block of the agri-food sector supplement:

- Partnerships along the food supply chain between: farmers and food industry; food industry and retailers; or food industry and equipment suppliers, are likely to have a significant potential for eco-innovation.
- Partnerships with researchers or other relevant knowledge suppliers may help to generate new ideas or knowledge that is relevant for eco-innovation.

## PR.3 Build the right external partnerships

- Open innovation platforms (e.g. allfoodexperts - <http://www.allfoodexperts.com/>, OpenUp - <http://www.letsopenup.se>) can bring external expertise to help SMEs with eco-innovation activities.
- Financial institutions – there are numerous funding schemes available for SMEs for innovations and increased sustainability performance. Examples of funding schemes are shown in table 2.

The involvement of international organizations and NGOs in the agri-food value chain is significant. These organizations have started a variety of initiatives, such as: SAVE-FOOD, Global Food Safety Initiative, OECD Food Chain Analysis Network, and the African Alliance for Improved Food-processing.

### References

UNIDO (2009). Funding Options for Small and Medium Size Enterprises to Finance Cleaner Production Projects and Environmentally Sound Technology Investments. Available from: [http://www.ioew.at/ioew/download/09-80065\\_Ebook-UNIDOFundingoptions.pdf](http://www.ioew.at/ioew/download/09-80065_Ebook-UNIDOFundingoptions.pdf)

Berndt, B. (2006). Timely Performance Measurement and Analytics in a Demand-Driven World. Available from: <http://www.foodqualityandsafety.com/article/timely-performance-measurement-and-analytics-in-a-demand-driven-world/?tzcheck=1>

## PR.4

Identify  
sustainability  
hotspots across  
the value chain

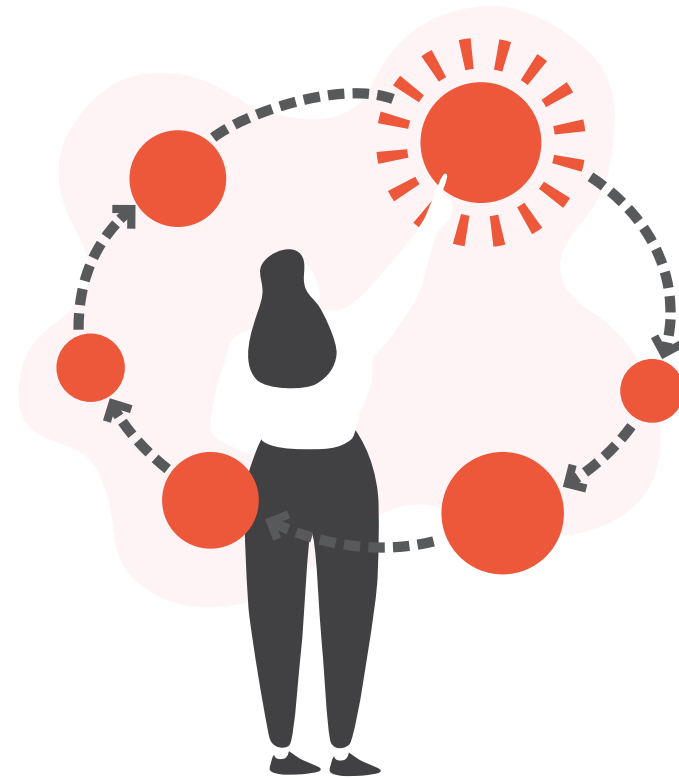

# PR.4 Identify sustainability hotspots across the value chain

## TIPS & TRICKS

### IDENTIFY WHICH STAGE OF THE VALUE CHAIN HAS THE HIGHEST SUSTAINABILITY IMPACT

When identifying the sustainability hotspots, keep in mind that majority of the environmental and social impacts are in the production stage of the value chain in many agri-food markets. The recent report *Food Systems and Natural Resources* from UN Environment International Resource Panel shows the relative impacts of different stages of the agri-food value chain (Figure 5). The impact of the production phase will vary between different markets, but is generally very high for animal based foods. → Refer to *Background Information* for more details.

Figure 5. Environmental sustainability impact of different stages of the agri-food value chain (UN Environment, 2016)

Natural Resources	Producing	Processing & packaging	Distributing & Retailing	Consuming	Managing waste
Renewable resources					
Land, soils and landscape	Cropping: grazing crop, hunting ●● ●●●	Sites for factories ●	Sites for transport and storage, infrastructure ●		Sites for landfill ●
Water	Irrigation: aquaculture ●● ●●●	Washing; cooking ●		Cooking ●	Dumping and removing waste ●
Biodiversity and ecosystems services	Pollination, pest control, water and nutrient regulation ●●●●	Biomass for paper and card ●	Livestock for transport ●	Food variety charcoal and wood for cooking ●●	Microbes to aid decomposition ●●
Generic resources	●●●●●	●			
Non-renewable resources					
Minerals	PK etc, for fertilizer and feed, chalk (liming) machinery ●●●●●	Iron, tin, bauxite (Al), kaolin and other resources for packaging ●●	Iron and other resources for transport, infrastructure ●●	Iron and other resources for cooking and storage, equipment ●	Iron and other resources for incinerators ●
Fossil fuels	Fertilizer and agricultural production, machinery ●●●	For cleaning, drying, processing, packaging ●●	For transport and warehousing, freezing and cooling, heating and lighting in shop ●●●	Cooking, cleaning ●	Collecting, recycling, purifying ●

# PR.4 Identify sustainability hotspots across the value chain

### IDENTIFY WHERE FOOD LOSS AND WASTE OCCURS IN THE VALUE CHAIN

Food loss and waste is a big issue in the agri-food value chain but also an opportunity for improvement and innovation. Different solutions are needed depending on where in the value chain food loss and waste occurs. In developing countries most loss and waste is generated during the production and handling and storage stages, while in developed countries it is in the consumption stage (Figure 6). In developing countries the loss and waste is generated mostly due to a lack of technology for storage and processing of food as well as a lack of cooperation between the value chain stakeholders, while in developed countries a large part of the waste is created due to unsustainable consumption behaviour.

Figure 6. Food loss and waste across the agri-food value chain (Lipinski, 2013).

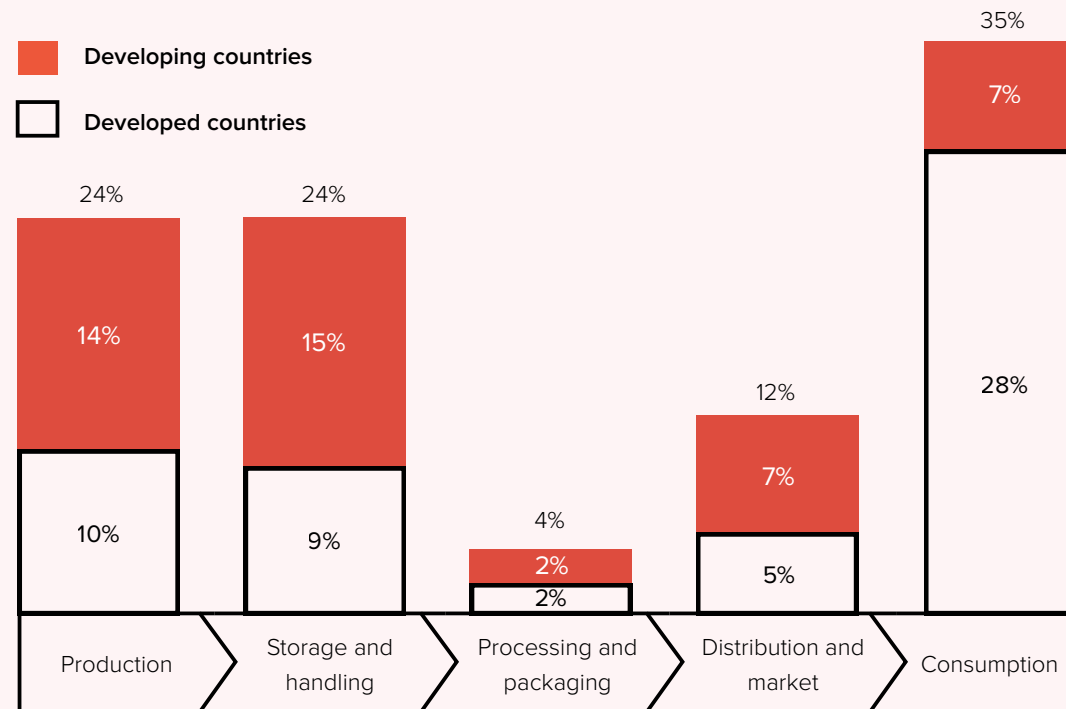

## PR.4 Identify sustainability hotspots across the value chain

From the diverse processed fruits and vegetable markets you have, at this stage, chosen to focus on the canned mango pulp market. You started by identifying all major stages in the canned mango pulp value chain, as shown in Figure 7. This figure helped to provide a basic understanding of the canned mango value chain and a systematic consideration of each stage of the mango life cycle and related inputs and outputs. The sustainability impacts of each stage of the value chain were detailed using the *Life Cycle Thinking* template. Lastly the sustainability hotspots were summarised completing the *Lifecycle Thinking* template.

Figure 7. Schematic representation of the life cycle of canned mango pulp

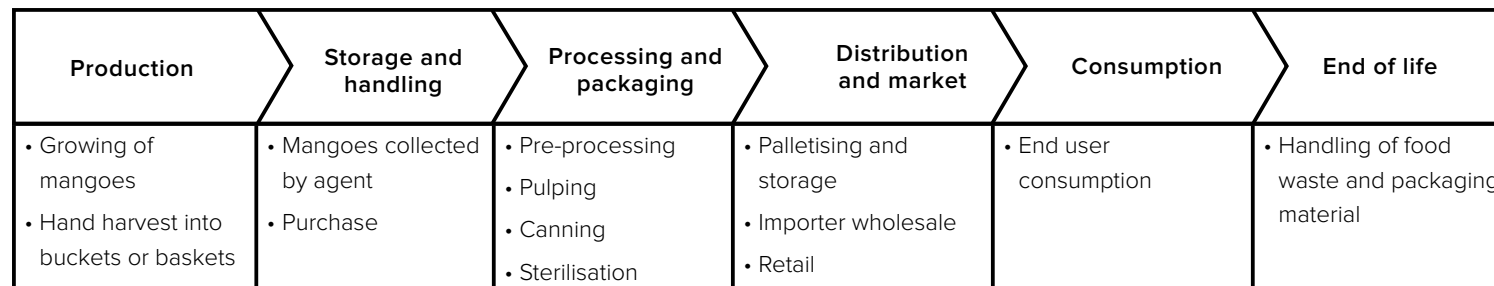



# PR.4 Identify sustainability hotspots across the value chain

## LEARNING CASE STUDY OF LIFE CYCLE THINKING

					Environmental impacts		Social Impacts			Economic impacts
Phase	Activity	Inputs	Product outputs	Emissions	Resource use	Ecosystem quality	On workers	On consumers	On stakeholders	Profitability
Production	Growing	<ul style="list-style-type: none"> <li>Fertilizers, pesticides, water, fuel (diesel)</li> </ul>		<ul style="list-style-type: none"> <li>GHG, solid waste, agri-chemical emissions to soil and water, lost mangoes</li> </ul>	<ul style="list-style-type: none"> <li>Resource depletion – fossil fuels and</li> <li>Phosphates (M)</li> <li>Water consumption (M)</li> </ul>	<ul style="list-style-type: none"> <li>Climate change (M)</li> <li>Soil degradation (H)</li> <li>Biodiversity loss (L)</li> <li>Land use (L)</li> </ul>	<ul style="list-style-type: none"> <li>Impact on health when handling agri-chemicals (H)</li> <li>Unsatisfactory working conditions and wages on farms (M)</li> </ul>			<ul style="list-style-type: none"> <li>Farmers growing others, more profitable crops (M)</li> <li>Revenue for farmers (M)</li> </ul>
	Harvest	<ul style="list-style-type: none"> <li>Fuel (diesel)</li> </ul>	<ul style="list-style-type: none"> <li>Fresh mangoes (at farm)</li> </ul>	<ul style="list-style-type: none"> <li>GHG, lost mangoes</li> </ul>	<ul style="list-style-type: none"> <li>Resource depletion – fossil fuels (L)</li> </ul>	<ul style="list-style-type: none"> <li>Climate change (L)</li> </ul>	<ul style="list-style-type: none"> <li>Seasonal jobs secured (M)</li> </ul>			<ul style="list-style-type: none"> <li>Cost of lost mango (M)</li> <li>Bad harvest practices can lead to lower quality outputs (M)</li> </ul>
	Transport to collectors	<ul style="list-style-type: none"> <li>Fuel (diesel)</li> </ul>	<ul style="list-style-type: none"> <li>Fresh mangoes (at agents)</li> </ul>	<ul style="list-style-type: none"> <li>GHG, waste water, lost mangoes</li> </ul>	<ul style="list-style-type: none"> <li>Resource depletion – fossil fuels (L)</li> </ul>	<ul style="list-style-type: none"> <li>Climate change (L)</li> </ul>	<ul style="list-style-type: none"> <li>Jobs secured for delivery driver (M)</li> </ul>		<ul style="list-style-type: none"> <li>Noise from trucks (L)</li> </ul>	<ul style="list-style-type: none"> <li>Cost of lost mango (M)</li> </ul>

					Environmental impacts		Social Impacts			Economic impacts
Phase	Activity	Inputs	Product outputs	Emissions	Resource use	Ecosystem quality	On workers	On consumers	On stakeholders	Profitability
Storage and handling	Sale by agent	• Electricity (100% coal)	• Fresh mangoes (at agents)	• GHG, waste water, lost mangoes	• Resource depletion – fossil fuels (L)	• Climate change (L)	• Jobs secured at agent (M)			• Cost of lost mango (H) • Revenue for agents (M)
	Transport to company	• Fuel (diesel)	• Fresh mangoes at (at factory)	• GHG, waste water, lost mangoes	• Resource depletion – fossil fuels (L)	• Climate change (L)	• Jobs secured for delivery driver (M)		• Noise from trucks (L)	
Processing and packaging	Pre-processing	• Ripening chemicals, chlorinated water	• Mangoes ready for processing	• Waste water, lost mangoes	• Resource depletion – Chemicals (L)	• Pollution to water and soil (L)	• Health concerns from handling ripening chemicals (M) • Jobs secured at factory (M)			• Revenue to manufacturer (M) • Cost of lost mango (M)
	Pulping	• Electricity and steam (100% coal), sugar, additives	• Mango pulp	• Waste water, solid waste (mango peel and seed), GHG, lost mango pulp			• Jobs secured at factory (M)			• Revenue to manufacturer (M) • Cost of lost mango (M)
	Canning	• Tin sheets, electricity (100% coal)	• Canned mango pulp	• GHG emissions, lost canned mango pulp	• Resource depletion – fossil fuels (L) • Depletion of tin (L)	• Climate change (L)	• Jobs secured at factory (M)			• Revenue to manufacturer (M) • Cost of lost mango (L)
	Heat treatment	• Electricity (100% coal)	• Canned mango pulp (at factory)	• GHG emissions	• Resource depletion – fossil fuels (M)	• Climate change (M)	• Jobs secured at factory (M)	• Increased food safety of canned mango pulp (H)		• Revenue to manufacturer (M) • Cost of lost mango (L)

					Environmental impacts		Social Impacts			Economic impacts
Phase	Activity	Inputs	Product outputs	Emissions	Resource use	Ecosystem quality	On workers	On consumers	On stakeholders	Profitability
Distribution and market	Storage at factory	• Electricity (100% coal)	• Canned mango pulp (at storage)	• GHG emissions	• Resource depletion – fossil fuels (L)	• Climate change (L)				
	Sales at wholesaler and retailer	• Electricity (100% coal)	• Canned mango pulp (at wholesaler/retailer)	• GHG emissions, lost canned mango pulp	• Resource depletion – fossil fuels (L)	• Climate change (L)	• Jobs secured at wholesalers/retailer (M)			• Cost of lost mango (L)
	Transportation to wholesale and retail	• Fuel (diesel)	• Canned mango pulp (at wholesaler/retailer)	• GHG emissions, lost canned mango pulp	• Resource depletion – fossil fuels (L)	• Climate change (L)	• Jobs secured for delivery driver (M)			
Use	Transportation by consumer	• Fuel (diesel, petrol)	• Canned mango (at consumer)	• GHG emissions	• Resource depletion – fossil fuels (L)	• Climate change (L)				
	Preparation (if used for cooking) and consumption	• Electricity (coal, water)	• Waste mango pulp, waster packaging material (at consumer)	• GHG emissions, food waste	• Resource depletion – fossil fuels (L)	• Climate change (L)		• High nutritional value of mango pulp (M)		
End of life	Waste disposal	• Fuel (diesel)	• Waste mango pulp, waster packaging material (at landfill)	• GHG emissions	• Resource depletion – fossil fuels (L)	• Climate change (L)	• Jobs secured at waste management (M)		• Bad odours from landfill site	

## PR.4 Identify sustainability hotspots across the value chain

The sustainability hotspots for the canned mango pulp value chain are summarised below. Some of the major hotspots include:

- Production: Use of harmful fertilizers and pesticides causing water and land pollution as well as exposing farmers to harmful chemicals
- Handling and Storage: Post-harvest waste is high.
- Processing: High-energy use for processes such as pasteurization, drying, frying, blanching, boiling etc.
- End-of-life: Packaging waste typically ends up in landfill without reuse or recycling.

### BACKGROUND INFORMATION

#### Sustainability hotspots in the agri-food value chain

The agri-food value chain has a major environmental, social and economic impact at the global and local level. Many agri-food subsectors, such as livestock farming, meat, and dairy processing are high on the priority list urgently requiring efficient resource management practices and sustainability improvements according to UN Environment's International Resource Panel (UN Environment, 2012).

The environmental impacts of the agri-food value chain include arable land depletion, greenhouse gas (GHG) emissions, deforestation, loss of biodiversity, pollution, potable water and non-renewable resource depletion. Also, the economic and social impacts of the agri-food value chain are substantial as the agri-food value chain employs a large part of the world's population. Furthermore, according to FAO, globally around 30% of the food suitable for human consumption is lost or wasted due to inefficient practices along the food value chain. This creates risks for food security and puts unnecessary pressure on natural resources (FAO, 2011a).

General hotspots in the agri-food value chain include:

- **Greenhouse gas emission** - 20% of global GHG emission is attributed to the agri-food value chain (Garnett, 2008). The largest contribution comes from the production stage in the value chain.
- **Consumption of non-renewable resources** - The agri-food value chain (including cooking and other preparation) consumes 30% of the global energy produced, most of which comes from fossil sources, making it a major contributor to non-renewable resource depletion (FAO, 2011b). Other non-renewable resources used by the agri-food value chain include metals, mostly for packaging, and non-metallic minerals, such as salts and phosphates.

## PR.4 Identify sustainability hotspots across the value chain

- **Pollution** - The agri-food value chain has a moderate contribution to pollution compared to other heavy industry. The largest contribution comes from the production and usage of fertilizers and pesticides. Soil and water are mostly polluted with nitrogen and phosphorus affecting the ecosystem as well as humans directly. There is also a major impact of heavy-metal containing fertilizers on reduction of arable land. Other pollutants from the agri-food value chain may include waste water, solid waste and air emissions by the processing industry.
- **Potable water consumption** - Agriculture is the largest user of water in all regions of the world except Europe and North America (AQUASTAT). Water is mainly used for irrigation of crops but is also consumed by livestock. For food and drinks products, the volume of water used in the processing stage is often less in the production stage. However, this will vary depending on the subsector (AQUASTAT).
- **Land use and degradation** -12% of the global land area is currently being used for cultivation of agricultural crops according to FAO (2011b). Poor practices in agriculture, such as over-cultivation, overgrazing and forest conversion, are a significant contributor to environmental problems such as degradation of soil quality and arable land depletion. Land degradation has accelerated during the 20th century due to the increasing and combined pressures of agricultural and livestock production, urbanization, deforestation, and extreme weather events, such as droughts and coastal surges (which salinate land).
- **Waste generation** - According to the FAO (2011a), 32% by weight, or approximately 24% by calorific value, of all food produced in

the world was lost or wasted in 2009. “Food loss and waste” refers to the edible parts of plants and animals that are produced or harvested for human consumption but that are not ultimately consumed by people. In particular, “food loss” refers to food that spills, spoils, is of inferior quality (unconventional shape, damaged etc.), or otherwise gets lost before it reaches the consumer. Food loss is the unintended result of an agricultural process or a technical limitation in storage, infrastructure, processing, packaging, or marketing. “Food waste” refers to food that is of good quality and fit for human consumption but that does not get consumed because it is discarded. Food waste is the result of negligence or a conscious decision to throw food away. Food loss and waste have many negative economic and environmental impacts. Economically, food waste is a lost investment that can reduce farmers’ incomes and increase consumers’ expenses. Environmentally, food loss and waste cause unnecessary greenhouse gas emissions and inefficient use of water and land.

# PR.4 Identify sustainability hotspots across the value chain

## References

UN Environment (2016) Food Systems and Natural Resources. A Report of the Working Group on Food Systems of the International Resource Panel. Westhoek, H, Ingram J., Van Berkum, S., Özay, L., and Hajer M. Available from: <http://www.unep.org/resourcepanel/KnowledgeResources/AssessmentAreasReports/Food>

Lipinski, B. et al. (2013). "Reducing Food Loss and Waste." Working Paper, Instalment 2 of Creating a Sustainable Food Future. Washington, DC: World Resources Institute. Available from: [http://www.wri.org/sites/default/files/reducing\\_food\\_loss\\_and\\_waste.pdf](http://www.wri.org/sites/default/files/reducing_food_loss_and_waste.pdf)

UN Environment (2012) Responsible Resource Management for a Sustainable World: Findings from the International Resource Panel. Available from: <http://www.unep.org/resourcepanel/Portals/50244/publications/SYNOPSIS%20Final%20compressed.pdf>

FAO (2011a). Global food losses and food waste – Extent, causes and prevention. Available from: <http://www.fao.org/docrep/014/mb060e/mb060e.pdf>

Garnett, T., (2008). Cooking up a storm: Food, greenhouse gas emissions and our changing climate. Available from: [http://www.fcni.org.uk/sites/default/files/CuaS\\_web.pdf](http://www.fcni.org.uk/sites/default/files/CuaS_web.pdf)

AQUASTAT Main Database.

Thematic discussion available from: [http://www.fao.org/nr/water/aquastat/water\\_use/index.stm](http://www.fao.org/nr/water/aquastat/water_use/index.stm)

FAO (2011b). The state of the world's land and water resources for food and agriculture (SOLAW) – Managing systems at risk. Available from: <http://www.fao.org/docrep/017/i1688e/i1688e.pdf>

## PR.5

Identify the general opportunities and threats across the value chain



# PR.5 Identify the general opportunities and threats across the value chain

## TIPS & TRICKS

### GATHER GENERAL INFORMATION ABOUT YOUR TARGET MARKET

Identifying markets and companies for eco-innovation requires substantial desk research and analysis. Important sources of information about the agri-food value chain can be found at:

- **International standards and guidelines** - Codex Alimentarius is a collection of international standards, guidelines, codes of practices and recommendations concerning: Food safety (HACCP, contaminants, pesticide residues, quality of water intended for food consumption, official control of foodstuffs, materials in contact with foodstuffs); Food hygiene (general rules, health rules concerning foodstuffs of animal origin); Food composition (additives, flavourings, processing

aids, GMOs); Labelling (general labelling rules, quantitative ingredient declaration, nutrients declaration, lot identification, unit pricing, expiration date). Codex standards are based on the best available science assisted by independent international risk assessment bodies or ad-hoc consultations organized by FAO and WHO. <http://www.codexalimentarius.org/>.

- **FAO** – The Food and Agriculture Organisation within the UN ([www.fao.org](http://www.fao.org)) has vast information about food and agricultural products. The website also hosts FAOSTAT - the most important source of data for global and national food prices, production, trade etc. Available from: <http://faostat3.fao.org>.

- **Legislation** - Food safety, hygiene and composition are regulated on a national level, usually by a food and drug administration. Some regional and national legislation concerning food can be found at the websites of FAO and WHO. It is important to keep in mind that in the case of exports, the manufacturer must comply with the regulations of the importing country.
- **Industry driven initiatives** – Global Food Safety Initiative (GSFI, <http://www.mygfsi.com/>) can be used to find relevant information about food safety and guidance for SMEs on how to improve their manufacturing process. European Food SCP Roundtable (<http://www.food-scp.eu/>) offers information about sustainability issues in the agri-food

value chain and provides guidance for companies in the whole food value chain on how to improve their sustainability performance.

- **Market specific industry initiatives** – such as Round Table for Sustainable Soy (RTRS, <http://www.responsiblesoy.org/>), Sustainable Spice Initiative (SSI, <http://www.sustainable-spicesinitiative.com/>), Roundtable on Sustainable Palm Oil (<http://www.rspo.org/>) or The Sustainable Rice Platform (<http://www.sustainable-rice.org/>) offer valuable information about specific markets and particular sustainability issues. Here you can find guidelines on sustainable practices and even market and trade data. Sustainability initiatives are co-operations between in-

dustry and NGOs and are active in many agri-food markets.

### USE OPEN INNOVATION

Open innovation platforms such as allfoodexperts, (<http://www.allfoodexperts.com/>) and OpenUp (<http://www.letsopenup.se>) gathers expertise within the agri-food value chain that can provide external input on SMEs' needs and ideas. Additionally the European food technology network HighTech Europe (<http://www.hightecheurope.com/>) through its innovation portal ([www.foodtech-portal.eu](http://www.foodtech-portal.eu)) provides useful information on latest technology, profiles of institutions and companies and services in food processing for those interested in open innovation.



## PR.5 Identify the general opportunities and threats across the value chain

### GATHER MARKET DATA

- **The Organisation for Economic Co-operation and Development (OECD)** – benchmarks, trade and market data and analysis of future trends (<http://www.oecd.org/> and <http://www.oecd-ilibrary.org/>). Future trends in food production can be found in the Agricultural Outlook (<http://www.oecd.org/site/oecd-faoagriculturaloutlook/>). The Agricultural Outlook, 2014-2023, is a collaboration between OECD and FAO. It brings together the commodity, policy and country expertise of both organisations and inputs from collaborating member countries to provide an annual assessment of prospects for the coming decade of national, regional

and global agricultural commodity markets.

- **Food industry associations** – such as Food-DrinkEurope (<http://www.fooddrinkeurope.eu/>) provides, among others, data about market and consumer trends in the European market. Many countries have national food industry associations which can provide data and information relevant to the local context.
- **Food industry forums** - use the forums to find the latest news and the “industry buzz”, as well as market trends and opportunities in your region. Some useful forum can be found at: <http://www.foodprocessing.com/>, <http://www.food-packagingforum.org/>

### GATHER INFORMATION ABOUT ENVIRONMENTAL PERFORMANCE OF TYPICAL PRODUCTS

Environmental data and guidance:

- **Life Cycle Assessment data (LCA)** – There are various LCA databases available online. The European reference Life Cycle Database (ELCD, <http://eplca.jrc.ec.europa.eu/ELCD3/index.xhtml>) and LCA Digital Commons (<http://www.lcacommons.gov/>) can be accessed for free.
- **Best available technique REFERENCE documents (BREFs)** - each document gives information on a specific industrial sectors in the EU, on the techniques and processes used in the sector, current emission and consumption

levels, techniques to consider in the determination of the best available techniques (BAT) and emerging techniques. Food, milk and drink processing is covered by BREFs as well as animal rearing. Available from: <http://eippcb.jrc.ec.europa.eu/reference/>

### IDENTIFY VOLUNTARY INITIATIVES SUCH AS ECOLABELS RELEVANT FOR THE MARKET

Ecolabels help to inform consumers about the sustainability performance of a particular product and support purchasing decisions. Obtaining an ecolabel for a product can help companies to access certain new markets where

such labels are a pre-requisite or are highly valued by customers. To receive an ecolabel a product has to comply with the guidelines of the label. There are over 200 different voluntary standards for food products, which can be confusing for both consumer and the industry. In order to compare different labels and get a general understanding of the requirements for certification, use: [www.standardsmap.org](http://www.standardsmap.org). Standards Map is an online tool developed by the International Trade Centre for producers and manufacturers to easily compare the performance and requirements of different labels. Standards Map can be accessed by institutional users from developing economies free of charge.

# PR.5 Identify the general opportunities and threats across the value chain

## LEARNING CASE STUDY OF PESTEL

The following table shows a completed PESTEL analysis of the processed fruit and vegetables market, as well as the significance of

each issue. Issues that are categorised as ‘opportunities’ are marked with red, while ‘threats’ are shown in grey.

Heading	Description of issue/trend	Time scale (0-6/7-24/24+ months)	Impact (1= Very low, 5= Very high)	Likelihood (1= very unlikely, 5= certain)	Significance (Impact x Likelihood)
Political	<i>The political situation is generally not stable which discourages foreign direct investments</i>	24+	3	2	6
	<i>The taxation policy is often changing</i>	7-24 months	2	3	6
	<i>The fruits and vegetables processing market is supported by the government in the National Development Plan</i>	0-12 months	4	4	16
Economic	<i>The availability and cost of fossil fuels is heavily affecting businesses as production, processing and distribution of foods are dependent on fossil fuels</i>	24+ months	4	3	12
	<i>Supply of raw material is unstable and total yield loss is possible due to lack of pest control at supplier farms</i>	24+ months	5	2	10
	<i>The Government has given a high priority to the agriculture value chain, providing a number of fiscal reliefs and incentives to encourage commercialisation and value addition to agricultural produce</i>	0-6 months	2	5	10
	<i>Government initiative to provide a 50% tax concession specifically for the fruit and vegetable industry</i>	0-12 months	3	4	12

## PR.5 Identify the general opportunities and threats across the value chain

Heading	Description of issue/trend	Time scale (0-6/7-24/24+ months)	Impact (1= Very low, 5= Very high)	Likelihood (1= very unlikely, 5= certain)	Significance (Impact x Likelihood)
Social	<i>Expected increase in consumption of processed fruits and vegetable due to a growing middle class</i>	<i>24+ months</i>	3	3	9
	<i>A growing urban and educated society is moving away from low quality snacks and carbonated soft drinks to healthier options.</i>	<i>24+ months</i>	3	2	6
	<i>High unemployment levels in local communities and rural migration</i>	<i>24+ months</i>	4	1	4
Technological	<i>Lack of chilled transportation and cold storage is limiting the processing of fruits and vegetables</i>	<i>24+ months</i>	2	4	8
	<i>Generally low technological awareness and automation</i>	<i>0-24 months</i>	2	3	6
	<i>Social media and enhanced IT systems are making it easier to identify trends in consumer buying behaviour and build brand awareness and loyalty, especially in the branded food and drink categories</i>	<i>24+ months</i>	2	4	8
Environmental	<i>More frequent periods of heavy rain and extended droughts are negatively affecting the supply of fruits and vegetables</i>	<i>24+ months</i>	5	1	5
	<i>Food and drink processing industry is the largest consumer of packaging material and creates large quantities of waste</i>	<i>24+ months</i>	3	4	12
Legal	<i>Food and drink processing is highly regulated by the Food and Drug Administration</i>	<i>24+ months</i>	2	4	8
	<i>Increasing consumer safety regulation</i>	<i>0-12 months</i>	2	4	8
	<i>Mandatory tracking and traceability requirement</i>	<i>0-6 months</i>	3	2	6

# PR.5 Identify the general opportunities and threats across the value chain

## BACKGROUND INFORMATION

### External factors affecting the agri-food value chain

Recently there has been an increased focus on sustainability challenges faced by the agri-food value chain. This has led to changes in how the companies, especially the multinationals, conduct business. This has important implications for SMEs as part of the global value chains. The increased focus on sustainability is largely due to heightened consumer awareness about the environmental and social impacts of food production, as well as recognition by companies of the economic advantages of tackling sustainability issues.

A number of external and internal factors affect the agri-food value chain (please see Table 3). A few are worth highlighting here for their implications for eco-innovation:

- Strong government support can be crucial in securing funding for eco-innovation activities and creating enabling policy environment. However, government involvement in terms of investment in research and development and incentivizing innovation and application of sustainable practices is inconsistent across countries and different markets.
- Legislation is creating stricter operational boundaries for food and drink processing businesses, e.g. through health, and safety standards and mandatory labelling. In many countries, many regulations exist to ensure safe and high quality food production. The situation can be further complicated by the rise of voluntary sustainability standards and labels. Lately, they have come to be seen as de facto regulation in globalized food value chains in view of heightened consumer concerns about food safety and multinational companies concern about the reputational risks. Being ahead of legislation can be challenging for SMEs but is an opportunity to stay operational and competitive.
- Margins in the agri-food value chain are generally low, which could be a limiting factor when applying the holistic approach of eco-innovation. Deviating from business-as-usual can be perceived as a significant risk in a low margin sector. However it is important to consider long-term impacts of continuing with business-as-usual. Eco-innovation utilises tools to identify the possible negative impacts of business-as-usual on a company and presents opportunities to mitigate these. For example, SMEs have the potential to enter high-end markets, or otherwise increase their margins, through new business strategies and business models.
- Consumer trends and preferences in food are shifting fast, particularly in rapidly urbanising areas. Consumer demand is placing greater emphasis on factors such as convenience, variety, nutrition, safety, presentation, and the origin of ingredients. Heightened awareness about safety and sustainability impacts and changing lifestyles are driving these demands. This requires a great deal of flexibility and foresight from food and drink processing companies to stay competitive (A.T. Kearney, 2012). This can be beneficial to SMEs that have a good understanding of their end consumers and are actively introducing changes and innovations to their operations in order to meet these demands. For example, in Asia, probiotic cultures for fortified dairy products is continuing to grow strongly with revenue projected to rise from US\$310 million in 2011 to US\$522.8 million in 2018. This is due to: increased research validating the health claims of improved intestinal health and immune system; the increasing affordability of probiotic products due to increasing purchasing power parity of consumers; and the growing focus on preventive medicine since the ageing population is expected to increase, particularly in Japan and Singapore (Frost and Sullivan, 2014).

# PR.5 Identify the general opportunities and threats across the value chain

- Technology plays a key role in the agri-food value chain. Investments in technologies can facilitate scaling up of operations in volume and quality through production innovations. Also, new information and communication technologies (ICT) can facilitate the adoption of innovative business strategies and models. Precision agriculture techniques can permit a reduction in material inputs for primary production, with minimal disturbance to the natural resources. ICT allows for greater traceability and transparency in value chains and instant access to information for customers. Cold chain technologies can offer energy efficient solutions for transport and storage of food. However with eco-innovation, technology also implies utilizing techniques most relevant and fit to a SME context through a holistic approach, rather than simply importing new or more advanced systems.
- Intensive use of natural resources is a key trait of many agri-food value chains. Agricultural production, which supplies raw materials to the food and drink processing industry, is dependent on environmental conditions. Increasing frequent periods of droughts and heavy rainfall in many regions have decreased agricultural yields, straining the ability of food and drink processing companies to secure a stable supply of raw materials. Additionally many food and drink processing businesses are strictly seasonal with dependence on a particular crop. These environmental impacts accumulate across the entire value chain, providing multiple opportunities for eco-innovation.

Table 3. Trends directly influencing the agri-food value chain (Accenture, 2011)

Market trends	Sustainability challenges/opportunities to engage in eco-innovation
<b>Growing environmental and social pressures</b>	<ul style="list-style-type: none"> <li>• Extreme weather conditions and temperature variations significantly impact productivity</li> <li>• Growing regulatory pressure from governments and civil society</li> <li>• Increase demand for transparency and traceability of food products</li> </ul>
<b>Increase in food security concerns</b>	<ul style="list-style-type: none"> <li>• Consumers increasingly demand safe and sustainable food products</li> <li>• Limited export in key producing regions</li> <li>• Increased land use for food production</li> </ul>
<b>Price volatility</b>	<ul style="list-style-type: none"> <li>• Price fluctuation of major food value chain inputs such as fertilizers, water, fossil fuel</li> <li>• Input costs are expected to rise in the near future</li> <li>• Raw material scarcity</li> </ul>
<b>Globalisation and growing role of developing countries in global trade</b>	<ul style="list-style-type: none"> <li>• Increasing need to improve value chain cooperation</li> <li>• Geopolitical risks</li> <li>• Globalized value chains</li> </ul>
<b>Changing consumption patterns and increasing demand from growing middle class</b>	<ul style="list-style-type: none"> <li>• Growing demand for food products</li> <li>• Increased demand for more sustainable products</li> <li>• Fast changing consumers preferences (increased variety of food, exotic food, healthy food, easy to handle food, time saving food, sustainably sourced food)</li> <li>• Aging population in developed countries</li> <li>• Significant changes in diets</li> <li>• Raw material and land scarcity</li> </ul>
<b>Technology and innovation</b>	<ul style="list-style-type: none"> <li>• Extensive use of water, energy and raw materials in the food value chain</li> <li>• Food waste and loss</li> <li>• Waste created from packaging</li> <li>• Increased legislative pressure on agri-food businesses</li> <li>• Increased public scrutiny and concerns about food safety</li> </ul>

## PR.5 Identify the general opportunities and threats across the value chain

### References

AT Kearney (2012), Recipe for Change: Can We Feed the World?

Front and Sullivan (2014). Asia Pacific's food industry demand to surpass North America and Europe combined by 2014. Accessed online at: <http://www.frost.com/sublib/display-press-release.do?id=288758712>

Accenture (2011), Achieving High Performance in the Agribusiness industry



## PR.6

Develop a value chain vision



## PR.6 Developing a value chain vision

### LEARNING CASE STUDY

All products from fruits and vegetables are sustainably sourced and processed.

Consumers are aware that their purchases have a direct positive effect on working condition, health and safety issues and wages of farmers and factory workers. The satisfaction is high among consumers and they are willing to pay a premium price for a sustainable product. There are continuous initiatives to improve the sustainability of the value chain through better agricultural practices, increased productivity, higher product quality, and enhanced food safety. The supply chain is transparent, disclosing information regarding origin of raw materials and relevant environmental and social aspects of the products and processes (such as use of chemicals and nutritional value) to the consumer.

The industry is able to meet the demand of a growing international market for healthy food through implementation of sustainable practices across the whole value chain. There is a strong cooperation between value chain stakeholders including private and public sectors, supporting a sustainable growth of the industry.

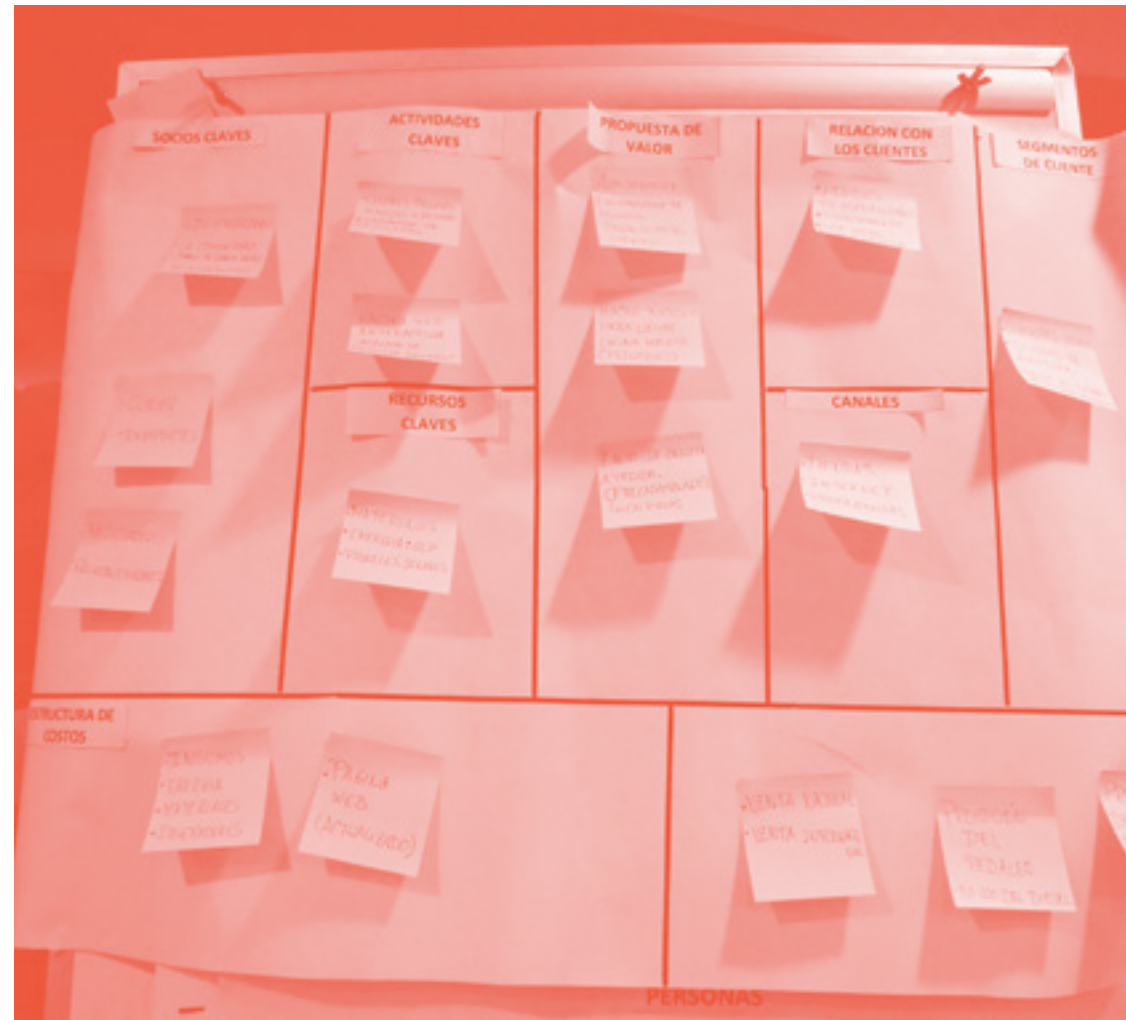



## PR.8

Plan and  
implement  
engagement  
activities



## PR.8 Plan and implement engagement activities

### BACKGROUND INFORMATION

At this point of the eco-innovation process, you have gathered all the necessary information on the target value chain and are ready to engage a company to offer your services as an eco-innovation service provider. From this point onwards in the supplement, we will use the hypothetical company Mango Pulp Co. as a learning case study to provide practical examples of implementation of the eco-innovation methodology and selected templates at a company within the agri-food value chain.

#### Description of Mango Pulp Co.

With the data you have gathered during the PREPARE phase, you have selected Mango Pulp Co. as a potential company for implementation of eco-innovation. The selection was made by reviewing fruit and vegetable processing companies within your own network as well as from a database of the National Export Promotion Agency.

Mango Pulp Co. showed the most potential for eco-innovation for reasons explained below:

- During your previous work with the company, you noticed a strong commitment from the company's management to pursue further opportunities to improve sustainability performance, including strategic changes.
- You believe that the benefits of eco-innovation for Mango Pulp Co. will outweigh the risk involved. The company is willing to accept a degree of risk if the risk is justified.
- The company has an efficient decision-making system.
- The company has not made any large investments in recent years.
- You have benchmarked the company against industry standards and found that there are still many opportunities for improvement.

A short introduction to Mango Pulp Co. is given below.

The Mango Pulp Co. was founded in 2008 by the current CEO of the company. He started the company in response to the growing demand for canned mango pulp in the export market. The company has one processing facility with capacity for approximately 3800t (metric tonnes) of mango pulp per year, which is currently running at 2500 Mt/year. The company has 21 permanent staff and additional 50 seasonal workers:

Permanent staff	Number
CEO	1
Marketing manager	1
Operations manager	1
Technology manager	1
Marketing and sales	2
Accountant	2
Electrician/Mechanic	2
Watchman/Guard	3
Buyers	4
Production supervisors	4
Seasonal production staff	50

Mango pulp is the concentrated mango juice obtained from processing various varieties of mangoes. The processed mango pulp has extended shelf life and has significant export potential. The mango pulp can further be used to produce downstream products like mango jam. The canned mango pulp has about two years of shelf life without cold storage. Canned mango pulp can be consumed as a fruit juice and in the processing of mango jam.



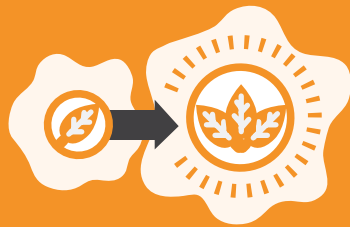
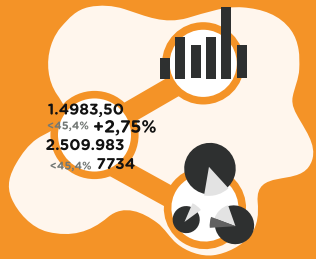

# SET STRATEGY

The aim of the SET STRATEGY phase is to use your knowledge of the company's strengths, weaknesses, opportunities and threats to propose a new business strategy that places eco-innovation at the core of the company's business strategy to ensure progress towards a sustainable future for the company



# ST.1

## Plan my data gathering strategy

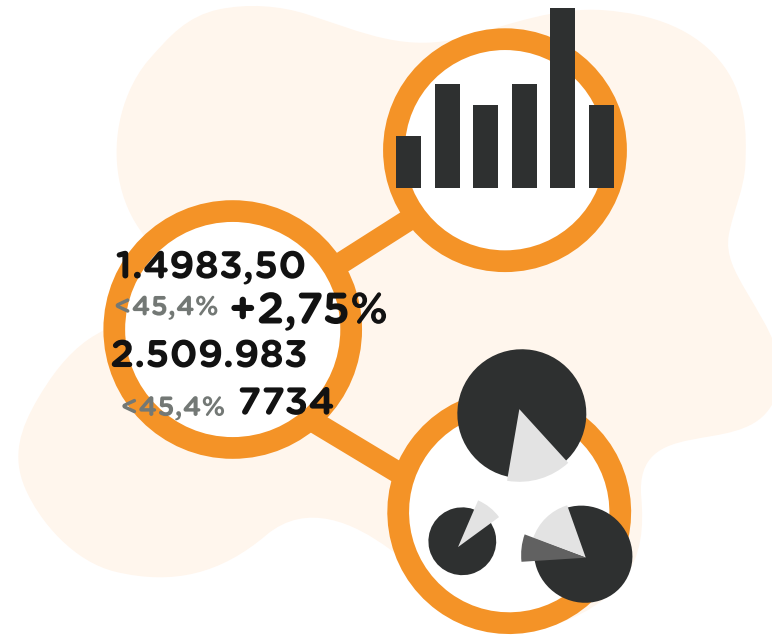

# ST.1 Plan my data gathering strategy

## TIPS & TRICKS

### KEY PERFORMANCE INDICATORS FOR THE FOOD AND DRINK PROCESSING INDUSTRY

Gather information about Key Performance Indicators (KPIs) for the food and drink processing industry to identify and measure sustainability hotspots in the value chain. KPIs for product categories such as grains, beef, milk, packaged cereal, beer, bread, farmed salmon, wine, and cotton have been defined by a number of organisations, such as the Sustainability Consortium (2012). However to access this, and many other sources, a membership is needed. For this reason it is useful to have an eco-innovation partner that has access to, or knowledge about, KPIs. Some of the common topics covered by KPIs can be found below with further information

- provided in the activity BM.3  
Gather additional data on operational performance  
Market pressures related to sustainability such as energy, water use, lack of resources and CO<sub>2</sub> emissions
- Price trends of raw materials e.g., cacao, wheat and sugar
  - Number of products produced and main markets
  - Distribution channels and retailers used
  - Overall Equipment Effectiveness (=availability \*performance\*quality)
  - Lean metrics: batch cycle time, inventory days supply (IDS), process velocity, etc.
  - Company sales, profit margins, etc.
  - Total costs: material, labour, management, safety, etc.

## BACKGROUND INFORMATION

### References

The Sustainability Consortium (2012). Food, Beverage and Agriculture Sector: Industry Impacts Global Sustainability Development within the Sustainability Consortium Available from: <https://www.sustainabilityconsortium.org/consortium-news/food-beverage-and-agriculture-sector-industry-impacts-global-sustainability-development-within-the-sustainability-consortium/#sthash.nt7hZ21H.dpuf>



## ST.2

# Interview the CEO



## ST.2 Interview the CEO

### TIPS & TRICKS

#### **DETERMINE THE TYPE OF BUSINESS STRATEGY THE COMPANY IS RUNNING**

The business strategy used by a food and drink processing company will likely depend on its size and position in the value chain. There are several different business strategies that food and drink processing companies generally apply (Perner, n.d.):

- **Horizontal integration** is commonly applied by multinational companies in order to reach many market segments with a variety of different brands. In this type of strategy growth is gained by acquisition of already established business in familiar industries. Large market share and economies of scales are some benefits of horizontal integration.

However there is an increasing concern from governments and the public about the markets for consumer goods are being controlled by few companies limiting the opportunities for smaller business to compete in the markets.

- **Vertical integration** is a strategy whereby a food and drink processing company buys another business that is up- or downstream in the value chain. Most commonly a company would acquire its suppliers in order to secure the supply of raw materials, or acquire a company downstream in the value chain in order to increase gains from the extra value adding step. For instance a slaughter house could acquire a farm to assure

supply or a meat processing plant to increase value addition. One of the drawbacks of vertical integration is the potential lack of managerial and operation knowledge to run a different business.

- **Specialization** strategies are often used to gain a competitive advantage in one particular market segment. Companies that specialize in one type of product or service can often gain economies of scale and bargaining power with suppliers because of the large quantities purchased. They also focus on process and technology development which allows for product/service with superior quality and performance.

- **Diversification** is a strategy where a food and drink processing company would produce several different products for different market segments. This strategy is less efficient than specialization as overall equipment effectiveness is lower and there are usually less benefits from economies of scale. On the other hand, diversification can mitigate several risks including: fluctuation of agricultural material prices, total crop losses at farming stage and changes in consumer demand.
- **Cooperatives** are organisational forms where several businesses operate jointly to obtain mutual benefits. For instance a cooperative can have a higher bargaining power

than a single company and can acquire services too expensive for single members. Cooperatives might also be setup for marketing purposes allowing its members to sell under a common brand. There are several different types of cooperatives, for instance: farmer cooperative, manufacturer cooperative and consumer cooperative. Successful cooperative put extra focus on governance in order to prevent and resolve disputes between its members. More information on cooperatives can be found at <http://www.fao.org/partnerships/cooperatives/en/>

# ST.2 Interview the CEO

## LEARNING CASE STUDY OF CEO INTERVIEW

### Business Strategy

An example from the Mango Pulp Co.'s current business strategy is provided below. The company's current KPIs are mainly focused on economic aspects and aim at increasing product sales, especially in the export market. The company is also interested in product innovation and want to diversify to reach new markets. Being a

relatively small company, Mango Pulp Co. does not have a well-documented business strategy. The current strategy was formulated as a result of interviews with the CEO and upper management. During the interview, it was apparent that the CEO is passionate about implementing eco-innovation, but there were also concerns about availability of finances.

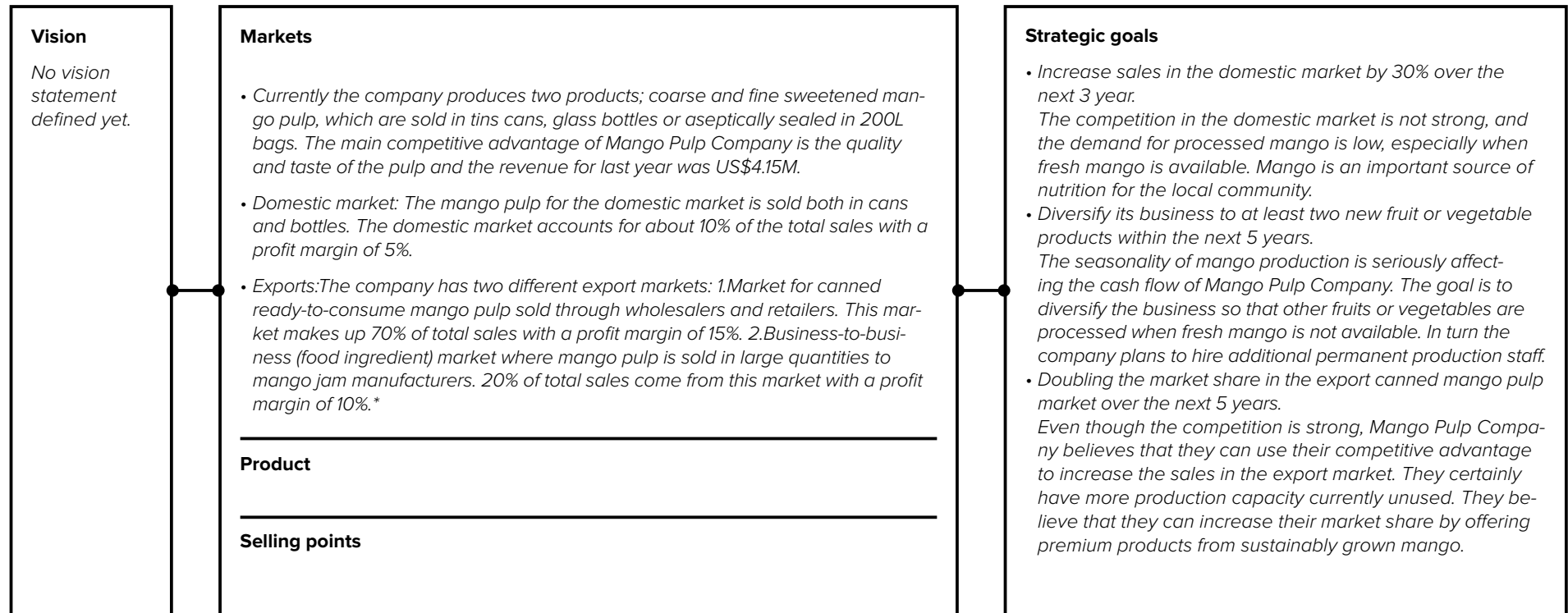

# ST.2 Interview the CEO

## LEARNING CASE STUDY

Product	% of total sales	Market position	Selling point (sp)
<i>Canned fine mango pulp</i>	70%	<i>Less than 5% market share of the export market</i>	<i>High quality, good sensory properties, long shelf-life</i>
<i>Coarse mango pulp</i>	20%	<i>Less than 5% market share of the food ingredient market</i>	<i>High quality, good sensory properties, low cost</i>
<i>Bottled fine mango pulp</i>	6%	<i>Top 3 in domestic market</i>	<i>Nutritious, good tasting, appearance</i>
<i>Canned fine mango pulp</i>	4%	<i>Top 3 in domestic market</i>	<i>Nutritious, good tasting, low cost</i>

## BACKGROUND INFORMATION

### Reference

Perner, L. (n.d.), Food Marketing, Consumption and Manufacturing  
 Available at: [http://www.consumerpsychologist.com/food\\_marketing.html](http://www.consumerpsychologist.com/food_marketing.html)

## ST.3

Capture the  
current business  
model



## ST.3 Capture the current business model

### LEARNING CASE STUDY OF BUSINESS MODEL CANVAS

The current value proposition of Mango Pulp Co. is that they make packaged mango pulp. It is the quality and taste that differentiate Mango Pulp Co. from its competitors and the reason why they can charge a higher price for their products.

They currently sell three products:

- canned mango pulp for the export wholesale market,
- bottled mango pulp for the domestic market, and
- mango pulp packaged in aseptically sealed bags in barrels that is exported to mango jam manufacturers.

Their operations consist of procuring mango from agents that collect mango from farmers, processing the mango, making cans and finally selling the packaged product. As they are only working business-to-business they are using direct sales as a sales channel as well as personal customer service. All this can be summarized in the business model canvas for Mango Pulp Co.:

Below you will find an example of a completed business model canvas for Mango Pulp Co.



# ST.3 Capture the current business model

<p><b>Key Partners</b></p> <p><i>Mango farmers</i></p> <p><i>Sales agents</i></p> <p><i>Transportation company</i></p> <p><i>Processing equipment supplier</i></p>	<p><b>Key Activities</b></p> <p><i>Mango procurement</i></p> <p><i>Mango processing</i></p> <p><i>Sales</i></p>	<p><b>Value Propositions</b></p> <p><i>High quality, good tasting, packaged mango pulp</i></p>	<p><b>Customer Relationships</b></p> <p><i>Personal service either face to face or by telephone</i></p>	<p><b>Customer Segments</b></p> <p><i>International wholesales and retailers</i></p> <p><i>Local retailers</i></p> <p><i>International mango jam manufacturers</i></p>
<p><b>Key Resources</b></p> <p><i>Processing facility</i></p> <p><i>Experienced permanent staff</i></p> <p><i>Loyal seasonal workers</i></p> <p><i>Suppliers</i></p>			<p><b>Channels</b></p> <p><i>Direct selling</i></p>	
<p><b>Cost Structure</b></p> <p><i>Mango procurement</i></p> <p><i>Labour</i></p> <p><i>Transportation</i></p> <p><i>Utilities</i></p> <p><i>Waste disposal</i></p> <p><i>Packaging materials</i></p> <p><i>Marketing</i></p>			<p><b>Revenue Streams</b></p> <p><i>Canned mango pulp</i></p> <p><i>Bottled mango pulp</i></p> <p><i>Aseptically packaged mango pulp</i></p>	

## ST.3 Capture the current business model

### BACKGROUND INFORMATION

#### Common business models used in the food and drink processing industry

The business model used by a food and drink processing company will greatly depend on the company's position in the value chain. For example, an ingredient manufacturer that is not selling directly to the end market might focus on price and functionality, while a manufacturer making consumer-ready products will focus more on quality and product differentiation. While performing the preliminary assessment, it may be useful to classify the business model(s) used by the company in order to highlight the key elements of the business model. The following table gives a summary of common business model in the food and drink processing industry and key elements of the business model.

Table 4. Business models used in the food and drink processing industry.

Type of business model	Description
Patented ingredients	Food ingredients that give increased functionality, nutrition or health benefits are often protected by patents. Revenue is made either by manufacturing and selling the ingredient or by selling licenses to manufacture and use the patented ingredient.
Branded ingredients	This type of business model is similar to the model above. The main difference is that the use of trademarked brand names by ingredient companies. Revenue is made by licensing the right to use the ingredient and brand name to companies downstream in the value chain. Using trademarked ingredients might add value to a food product.
Product and technology based	This model refers to companies that manufacture and sell their own food ingredients/products. The key elements of this type of business model are companies relying on their key resources such as competence and technology to manufacture a competitive food product. The marketing strategy, which is an important aspect of the business model, can vary from companies that are cost oriented to companies that cater to niche and high-end markets.
Processing services	This business model is also based on products and technology, but refers to companies offering a processing service rather than selling their own product. The processing service is offered to other food companies with established brand names, to food distributors as private label products, or to primary producers as a value-adding service. Globally, the consumer market for food products is very competitive. This makes it difficult for new products to enter the market. For this reason this business model might be used by companies without enough marketing resources.
Service innovation	A food company can base its business model around innovative services offered to consumers. For example, online retailing and home delivery of groceries is increasing in popularity.
Subscription/recurring revenues	A business model based on recurring revenues is still quite uncommon in the food industry. However there are a few examples of companies succeeding. Notable the Nespresso® business model is based on selling coffee machines at a low margin while making profit from sales of capsules designed specifically for the Nespresso® machine.



# ST.4

## Do a Walk-Through Audit



# ST.4 Do a Walk-Through Audit

## TIPS & TRICKS

### IDENTIFY MAJOR INPUTS AND OUTPUTS

Before beginning the walk-through audit, you should prepare walk-through audit sheets that list all the key issues to be checked or discussed when visiting the site. A template for completing a *Walk-Through Audit* is provided in the Eco-Innovation manual. Additional guidance on doing a walk-through audit in a food and drink processing company can also be found at: [http://www.wrap.org.uk/sites/files/wrap/WRAP\\_Food\\_Drink\\_Manufacturers.pdf](http://www.wrap.org.uk/sites/files/wrap/WRAP_Food_Drink_Manufacturers.pdf). Not all of the issues presented in the guidelines will be relevant, but think about where they could be applied in the company. Identify all the processing steps and key inputs and outputs.

Figure 8 shows some of the inputs and outputs from the food and drink processing industry. Be as specific as possible when identifying the processes, materials, and energy balances.

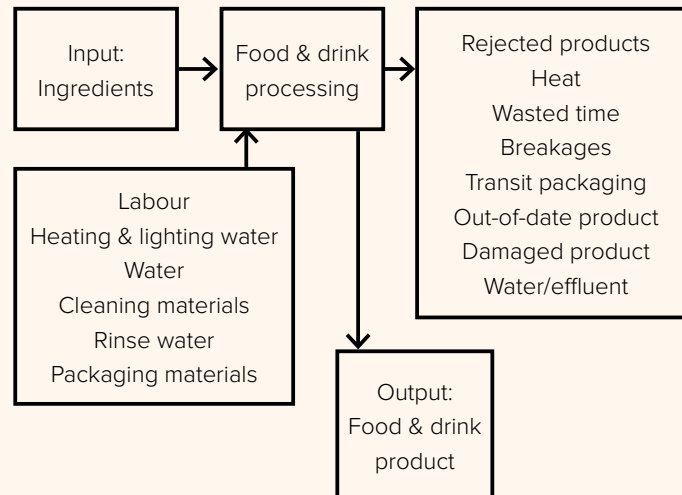

Figure 8. Generic process flow chart for a typical food and drink manufacturing process (WRAP, 2013)

## ST.4 Do a Walk-Through Audit

### LEARNING CASE STUDY

During the walk-through audit you have learnt about the current operations of Mango Pulp Co. and identified some of the challenges they are facing. The results of the audit are given in Figure 9.

The results of the walk-through audit were summarised to get a more comprehensive overview of the challenges in the Mango Pulp value chain. Some of the issues for Mango Pulp Company identified are:

**Untrained farmers** – seasonality and low wages are creating a high turnover of the workforce working at mango orchards. Thus, little or no resources are spent on training and education of the workforce in good agricultural practices. The consequence is lower quality and yields of mango production.

**Limited access to good quality planting materials** - There is a general shortage of grafted planting materials of higher-yielding varieties in many areas. Farmers often use inferior seedlings obtained by germinating mango seeds from indigenous varieties. Such ungrafted trees take much longer to bear fruit. Whereas grafted trees begin to bear fruit within 3 to 4 years, ungrafted trees will take at least 5 years to bear fruit, depending on the growing conditions.

**Pest and disease problems** – Mango trees can be affected by many pests and diseases, which can have devastating consequences and sometimes result in total yield loss. Major pests include the fruit fly (*Bactrocera invadens*), seed weevil (*Sternochetus mangiferae*) and mealy bugs (*Rastrococcus invadens*). Diseases like anthracnose and powdery mildew are common in almost all mango growing areas.

**Mango tree neglect** - In many areas, mango trees are left to grow so big that pest and disease management, harvesting and other field operations are difficult to implement. Except in big or commercial farms, mango trees are normally scattered around the gardens, ranging from 2 to 100 trees per household. This scattered nature makes mango a commonly neglected crop in terms of management, but becomes important during the harvesting season.

**Limited returns from mango production** - Mango production is highly seasonal and harvest is only expected at certain times of the year, depending on the local conditions. During this time, most areas are harvesting and so the local markets are saturated and, therefore, offer very low prices, which may not even cover transportation costs.

**Unstable quality and quantity of mango:** The quality and quantity of the incoming mango changes significantly during the season as well as between different seasons. The mangoes needed for pulping have to meet several requirements in order to maintain the desired quality of pulp, such as: lack of insect infestation, lack of mechanical injury, stage of maturity, uniform texture, minimum soluble solids of 13° Brix (sugar content) and a pH between 3.5 and 4. Mangoes that do not meet the requirements are discarded.

**Post-harvest losses:** Mango is highly perishable and therefore susceptible to postharvest losses. Fruit damage is a common problem as a result of poor pest and disease management and the poor harvesting practices. Also, a lot of fruit is lost after harvest, especially during the peak seasons due to the limited capacity to store and process fruit. Poor roads and transport infrastructure to reach markets further worsen this problem.

# ST.4 Do a Walk-Through Audit

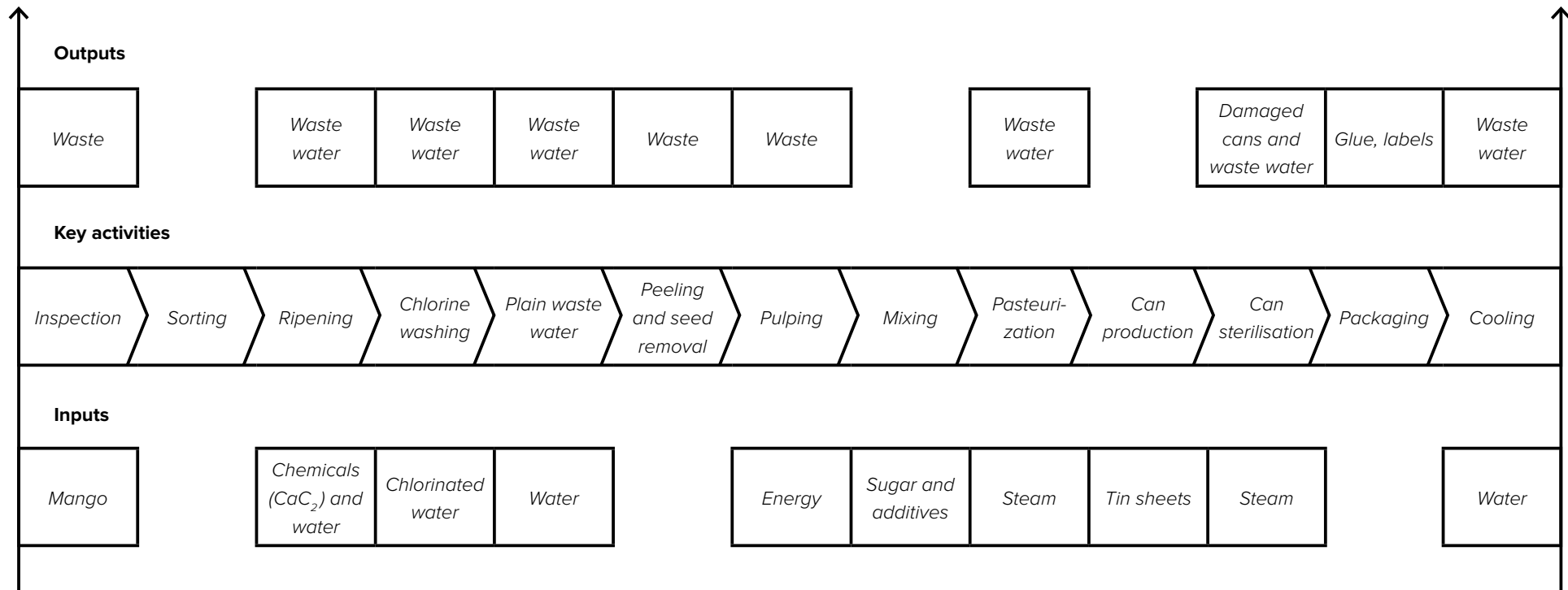

Figure 9. Current operations of Mango Pulp Co.

**High waste generation during processing:** As well as the mangoes that are discarded as unfit for pulping, waste is generated along the whole processing line. Much of the organic matter is removed during peeling and seed removal. Some is also lost during pulping as not all of the pulp can be pumped out of the tanks with the current technology. Finally, only 40% of the incoming

mango by weight is converted into pulp, which is significantly lower than the industry average of 55%. The organic waste is collected and disposed of by using municipal services that are costly. During high season locals have also complained about the odour coming from the facility.

## ST.4 Do a Walk-Through Audit

### BACKGROUND INFORMATION

**Ripening mangoes with Calcium Carbide (CaC<sub>2</sub>):** Mangoes are ripened using Calcium Carbide, which is a toxic chemical and extremely hazardous. It is perceived as the most economical way to ripen a mango, but a banned chemical in many countries, and should not be used for ripening of fruits. Fruits ripened with chemicals often do not ripen uniformly and the quality of the final fruit can be lower. Using ethylene gas for ripening might be a better option, as it is not associated with any food safety issues.

**Lack of quality and safety control:** Lack of quality and safety control throughout the value chain, as well as in processing itself, is limiting the ability of Mango Pulp Co. to compete in export markets. Meeting quality and safety standards such as ISO9000 or ISO22000 is crucial for realising the high export potential of mango pulp.

**Chlorine washing:** Chlorine is used to eliminate pathogens on the surface of the mangoes. However, chlorine is poisonous and can have negative health effects and can be a pollutant if released into the environment. Chlorine is also highly corrosive and damages the equipment used for washing.

**Impact and cost of distribution:** Depending on the intended market, the mango pulp is transported by sea or road. The cost of distribution is dependent of fossil fuel costs and has a substantial impact on the environment.

**Waste generation in consumption and end-of-life:** Packaged mango creates a lot of solid waste from packaging materials, such as tin cans, glass bottles and plastic. In many countries, the cans and bottles are not reused or recycled and go to landfill. Also, the size of the packaging is not adjusted to contain the correct portion for end consumers, resulting in the excess mango being wasted.

#### References

WRAP (2013). Business Resource Efficiency Guide: Self-assessment Review for Food and Drink Manufacturers. Available from: [http://www.wrap.org.uk/sites/files/wrap/WRAP\\_Food\\_Drink\\_Manufacturers.pdf](http://www.wrap.org.uk/sites/files/wrap/WRAP_Food_Drink_Manufacturers.pdf)



## ST.6

Update the  
sustainability  
hotspots

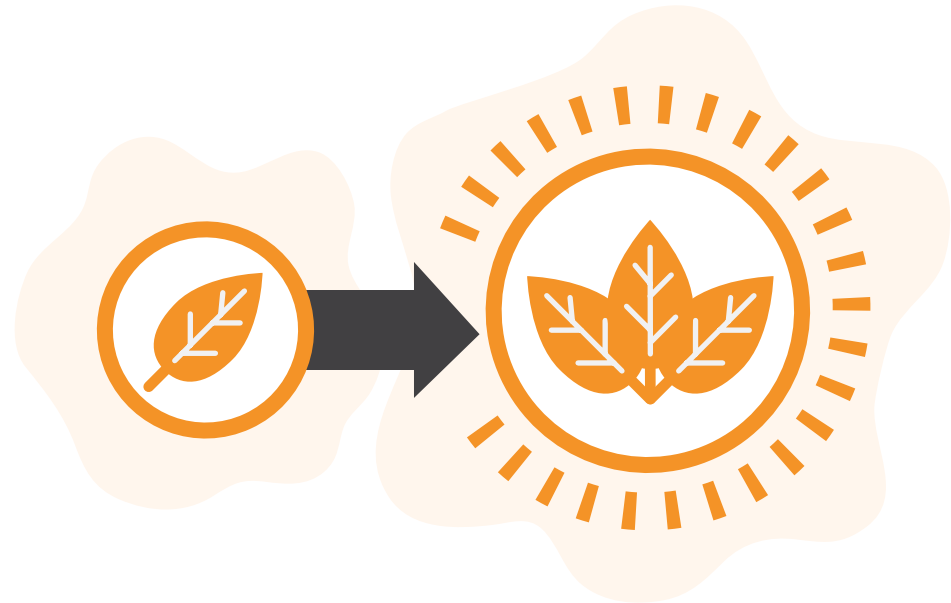

# ST.6 Update the sustainability hotspots

## TIPS & TRICKS

**USE THE NEW INFORMATION GATHERED TO IDENTIFY HIGH SUSTAINABILITY IMPACTS**

With the additional information gained by conducting a Walk-Through Audit and workshop at the company, revisit the Tips and Tricks from the activity PR.4 Identify sustainability hotspots across the value chain, and try again to identify which stage in the value chain has the highest sustainability impact. This could be closely linked to where most waste is generated, most energy is used or where the working conditions are stressful.

## LEARNING CASE STUDY

After conducting the Walk-Through Audit and a workshop at Mango Pulp Co. you have updated the sustainability hotspots using the *Life Cycle Thinking* template.

Below the sustainability hotspots for the Mango Pulp Company are listed along with examples of stakeholder and ideas for how what stakeholder could help to address the relevant hotspot

Table 5. Sustainability hotspots for Mango Pulp Company and ideas how stakeholder could help to address them.

Sustainability hotspot	Stakeholder and how they could help
<i>Risk of total yield loss at mango orchards</i>	<ul style="list-style-type: none"> <li>• Farmers – put more effort into management of mango orchards</li> <li>• Farmer association – provide pest control training to farmers</li> </ul>
<i>Unstable quality and quantity of supplied mango</i>	<ul style="list-style-type: none"> <li>• Local government – give incentives to mango farmers to plant more suitable varieties of mango</li> <li>• Financial institution – provide credit to farmers</li> </ul>
<i>Significant loss and waste</i>	<ul style="list-style-type: none"> <li>• University – help with finding solutions for minimizing mango loss and waste in the value chain</li> </ul>
<i>Concern about working condition due to use of chemical at farms and for ripening</i>	<ul style="list-style-type: none"> <li>• Fertilizer and ripening agent supplier – provide organic solutions for fertilizing and ripening</li> </ul>



## ST.7

# Do a SWOT analysis



# ST.7 Do a SWOT analysis

## LEARNING CASE STUDY OF SWOT

During the *PREPARE* and *SET STRATEGY* phase you have gathered information that allows you to proceed with further analysis. Important strategic factors can be summarised in a *SWOT* matrix.

The following *SWOT* analysis conducted for Mango Pulp Co. Many of the strengths and weaknesses of Mango Pulp Co. were identified during the walk-through audit and workshop conducted during the preliminary assessment. Others were identified while interviewing the CEO and capturing the current business model. Opportunities and threats are external attributes and were already identified during initial desk research for completing the *Target Identification* template. The *PESTEL* template completed during the *PREPARE* phase provided a number of useful points for completing the *SWOT* matrix. Opportunities and threats were also identified during the interview with the CEO, in the *Life Cycle Stakeholder* template and in the *Life Cycle Thinking* template.

	Helpful - to becoming more sustainable	Harmful - to becoming more sustainable
Internal origin (attributes of the company)	<p><b>STRENGTHS</b></p> <ul style="list-style-type: none"> <li>• High quality products available</li> <li>• Experienced permanent staff</li> <li>• Proximity to suppliers</li> <li>• High production capacity and potential to increase production</li> </ul>	<p><b>WEAKNESSES</b></p> <ul style="list-style-type: none"> <li>• Low yields in mango processing</li> <li>• Unsteady cash-flow</li> <li>• Expensive waste disposal</li> <li>• Manual labour-intensive production process</li> <li>• Limited capacity for product development</li> <li>• Lack of quality control</li> <li>• Use of toxic chemical during ripening</li> <li>• Use of chlorine during washing</li> </ul>
External origin (attributes of the environment)	<p><b>OPPORTUNITIES</b></p> <ul style="list-style-type: none"> <li>• Little competition in the domestic market</li> <li>• Good relationship with suppliers of raw materials such as mango sale agents, chemical suppliers and sugar suppliers</li> <li>• Growing demand for sustainably produced food in the export market</li> <li>• Diversification of products</li> </ul>	<p><b>THREATS</b></p> <ul style="list-style-type: none"> <li>• Unstable quality and quantity of raw materials</li> <li>• Untrained farmers causing large losses of mango</li> <li>• Climate change negatively affecting mango supply</li> <li>• Instability of labour</li> <li>• Strong competition in the export market</li> </ul>

## ST.8

Develop a vision  
for the company

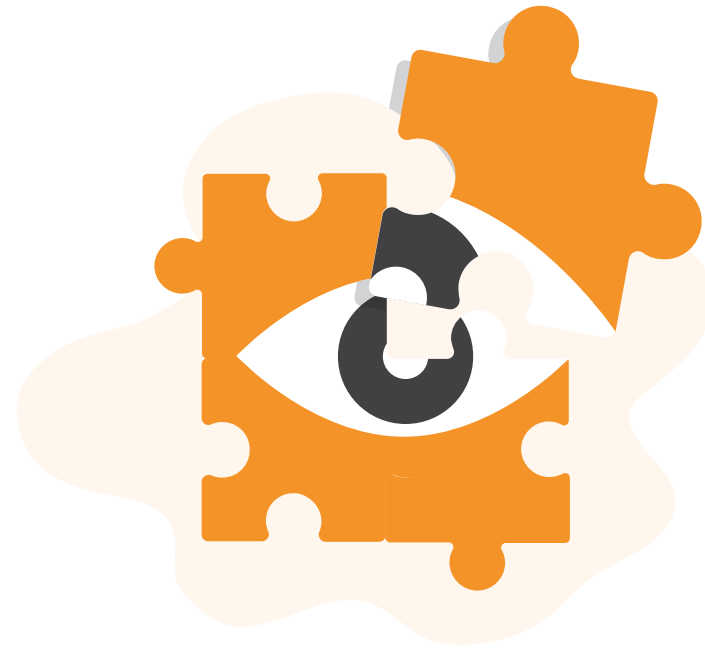

# ST.8 Develop a vision for the company

## LEARNING CASE STUDY OF COMPANY VISION

**SWOT**

**Value chain vision**

**Company Vision for the Mango Pulp Company**

*Our vision is to bring sustainably sourced and manufactured fruit and vegetable products to our consumer in the domestic and export markets thorough collaboration with our value chain partners.*

*The health and wellbeing of our current and future consumers is our primary focus. For this reason we provide food that is sustainable, safe, healthy and nutritious. We communicate this message to consumers through appropriate certifications.*

*Additionally, we bring pleasure to our consumers by offering the highest quality, best taste and convenience.*

---

**Feedback**

## ST.9

Define the  
strategic goals



# ST.9 Define the strategic goals

## TIPS & TRICKS

### CONSIDER STRATEGIES BASED ON VALORISATION OF WASTE STREAMS

Try finding strategies where sustainable solutions will have a direct economic benefit for the company. For instance:

- Energy efficient processing solutions
- Solutions for more efficient use of raw materials
- Valorisation of by-products (e.g. products for new markets, biogas production from waste, composting. A real example is shown in the case study below)

### Industry example 1: HWP Fresh and Dry Ltd

HWP Fresh and Dry Ltd is a Ghanaian company that specialises in processing off-specification or reject fresh fruits meant for the export market. Their main product is high quality dried pineapple, mango, banana and coconut flakes/chips, which is sold to retail customers all over Europe as snack product for people on the move. The main goal of HWP Fresh and Dry Ltd is to grow on the fruit export business in Ghana by adding value through processing of fruits that cannot be exported.

The company introduced a new business strategy focused on a holistic implementation of waste minimization and re-use. The change in strategy came as a response to the increasing cost of waste generation both at the out-grower farms and during processing. This was crippling the profitability of the out-grower farmers and the fruit export business, and limiting the opportunity to penetrate the European market. The new strategy involved creating new products for new target markets with higher profit margins based on new processing alternatives, effective raw material utilisation, and better use of by-products.

The aim was to process locally available mango, banana and coconut for which no local or export market exists into healthy snacks for health conscious consumers in West Africa and Europe. The new business strategy of HWP Fresh and Dry Ltd can be summarised as:

### Strategic goals:

- Make full use of locally available raw material for which no market existed
- Use non-product organic waste to generate biogas that is used as energy to power the dryers in the production processes (waste-to-energy)
- Increase company's earnings through value addition

### Key markets:

- European and West African market for healthy snack products

The company is now also working closely with suppliers to increase fruit production and meet the fruit specification for processing.

The fruit are then sorted according to colour, ripeness, brix and translucency. Fruits meeting the quality are washed, cut and peeled, weighed, dried into flakes and bagged for export. All organic process waste generated (juice, peels, fibres) are fed into the biogas digester for biogas production.

Because of the eco-innovative approach to their business strategy HWP Fresh and Dry Ltd has improved their economic performance while also addressing some social and environmental concerns. The benefits of eco-innovation for HWP Fresh and Dry Ltd can be summed up as:

### Economic:

- Company's earnings doubled in 18 months
- New orders received from retailers in Europe and West Africa
- Waste disposal costs minimized

## ST.9 Define the strategic goals

- 25% of the company's energy requirement fulfilled from biogas produced from the process waste
- 10% energy supply from solar thermal panels installed

### Environmental:

- Reduction in GHG emissions from switch to biogas and solar
- Green rating from the Environmental Performance and Public Disclosure AKOBEN program

### Social:

- Out-grower farmers have a strong market demand for their produce
- Company pays 10% higher prices per tonne of fruits to its out-grower farmers
- Dry fruits offer a healthy snack option to consumers
- The company has created direct additional employment. It now employs 450 people – 190 of whom are female.



# ST.9 Define the strategic goals

## LEARNING CASE STUDY OF TOWS

	<p><b>STRENGTHS</b></p> <ul style="list-style-type: none"> <li>• High quality products available</li> <li>• Experienced permanent staff</li> <li>• Proximity to suppliers</li> <li>• High production capacity and potential to increase production</li> </ul>	<p><b>WEAKNESSES</b></p> <ul style="list-style-type: none"> <li>• Low yields in mango processing</li> <li>• Unsteady cash-flow</li> <li>• Expensive waste disposal</li> <li>• Manual intensive production process</li> <li>• Limited capacity for product development</li> <li>• Lack of quality control</li> <li>• Use of toxic chemical during ripening</li> <li>• Use of chlorine during washing</li> <li>• Labour intensive</li> </ul>
<p><b>OPPORTUNITIES</b></p> <ul style="list-style-type: none"> <li>• Little competition in the domestic market</li> <li>• Good relationship with suppliers of raw materials such as mango sale agents, chemical suppliers and sugar suppliers</li> <li>• Growing demand for sustainably produced food in the export market</li> <li>• Diversification of products</li> </ul>	<p><b>STRENGTHS-OPPORTUNITIES strategy ideas</b></p> <p>Use the proximity and good relationship with suppliers to procure sustainably grown mangoes in order to meet the demand for sustainable food products in the export market</p> <p>Increase production by diversifying manufacturing to other fruits and vegetables</p>	<p><b>WEAKNESSES-OPPORTUNITIES strategy ideas</b></p> <p>Diversify manufacturing to other fruits and vegetables that can be processed in the off-season for mango.</p> <p>Switch to organic chemicals for processing.</p> <p>Work with equipment suppliers to increase the processing yields of mango pulp.</p>
<p><b>THREATS</b></p> <ul style="list-style-type: none"> <li>• Unstable quality and quantity of raw materials</li> <li>• Untrained farmers causing large losses of mango</li> <li>• Climate change negatively affecting mango supply</li> <li>• Instability of labour</li> <li>• High competition in the export market</li> </ul>	<p><b>STRENGTHS-THREATS strategy ideas</b></p> <p>Cooperate with farmers and suppliers to secure an even flow of high quality raw materials</p> <p>Offer training services to farmers in order to decrease mango losses</p> <p>Use 'high quality' in addition to 'sustainability' as a selling point in the export market</p>	<p><b>WEAKNESSES-THREATS strategy ideas</b></p> <p>Increase capacity for in-house process and product development by attracting skilled workforce</p> <p>Acquire organic label and use it as a selling point for the export market</p>



# ST.9 Define the strategic goals

## LEARNING CASE STUDY OF STRATEGIC GOALS

STRATEGIC GOAL #1	
What hotspot or other SWOT issue does the goal help to address?	High demand for sustainably produced food in the export market, but also a strong competition.
What is the desired change?	Increase in competitiveness in the export market through improved product qualities and marketing activities.
How will you know if the goal has been achieved?	Sales volumes, profits and market share in the export market across different products will be tracked.
When will the change be achieved?	Within five years
Final formulation of the goal:	Increase sales by 100% in the export market within 5 years through marketing of sustainable products.





## ST.11

Evaluate ideas  
for new markets,  
products and  
selling points

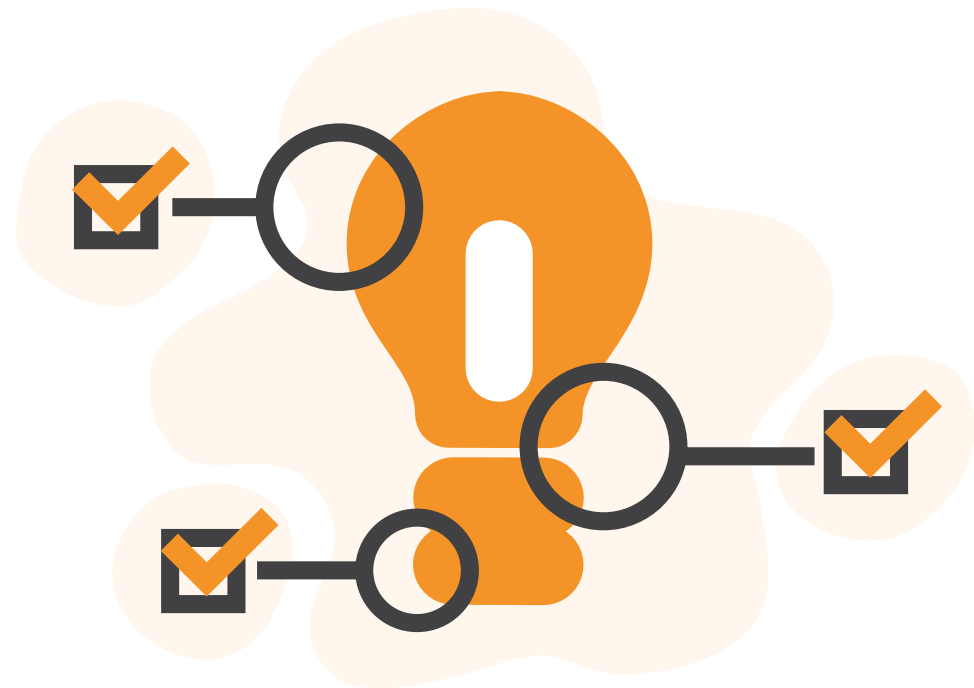

# ST.11 Evaluate ideas for new markets, products and selling points

## LEARNING CASE STUDY OF STRATEGY IDEA EVALUATION

**Idea title** Use sustainably sourcing of the mangoes and health benefits as selling points for existing products

RISKS				BENEFITS		
Type of risk	Description	Existing or new?	Risk score	Type of benefit	Description	Fit with goals
Product	Mango pulp	Existing	0	Economic	Estimated total available market of US\$ over 10M growing at 13% per year	Contributes to the goal of increasing sales by 100% in the export market within 5 year through marketing of sustainable products
Market	Domestic and export markets with a strong interest in sustainability	New	1	Environmental	Reduces the amount of agrochemicals used in mango production by 100% and eliminates the use of all toxic chemicals (e.g. calcium carbide) during processing	
Selling point	Sustainable and healthy	New	1	Social	Eliminates handling of hazardous chemicals for farmers and factory staff. Health benefits for consumers.	
			Total			
			Risk rating	High		

## ST.13

Do an individual/  
group review  
of the business  
strategy proposal



# ST.13 Do an individual/group review of the business strategy proposal

## LEARNING CASE STUDY OF BUSINESS STRATEGY

After completing the SWOT analysis matrix and listing all the significant strategic factors that you noted from your work with Mango Pulp Co., you have now prioritized the strategic factors. You have also considered and prioritised the major life cycle sustainability hotspots for canned mango pulp. Based on your analysis you have decided to suggest a diversification strategy for the management of the Mango Pulp Co.

The priority factors identified were: customer demand (local and regional) for high quality affordable products with low impact on the environment; problems caused by seasonality of mango; unstable supply of mango; low processing yields; and high waste in the value chain. The new strategic goals were based on these prioritized strategic factors.

The next step was to select the markets to target. Targeting market segments that have shown a strong interest in sustainably produced mango pulp offers growth potential for Mango Pulp Co. Additionally, the company might consider diversification to other fruits and vegetables to cope with the seasonality of mango and increase their production. The complete strategy proposal for the Mango Pulp Co. is described below.

### Vision

*Our vision is to bring sustainably sourced and manufactured fruit and vegetable products to our consumer in the domestic and export markets thorough collaboration with our value chain partners.*

*The health and wellbeing of our current and future consumers is our primary focus. For this reason we provide food that is sustainable, safe, healthy and nutritious. We communicate this message to consumers through appropriate certifications.*

*Additionally, we bring pleasure to our consumers by assuring the highest quality, best taste and convenience.*

### Market

- Domestic food retail market segments worth US\$ 20k-500k for sustainably sourced fruits and vegetable products
- Export food wholesale and retail market segments for sustainably sourced fruit and vegetable products worth more than US\$10M
- Export food ingredient market for mango jam manufacturers that are producing jam from sustainably sourced mango worth about US\$1M

### Product

*To be added*

### Selling points

- QUALITY
- FOOD SAFETY
- HEALTH
- TASTE
- SHELF-LIFE
- SUSTAINABILITY

### Strategic goals

- Increase sales by 100% in the export market within 5 year through marketing of sustainable products
- Diversify business to 3 new fruit or vegetable products in the next 5 years to compliment mango pulp production
- Secure a flow of 6000Mt/year (metric tonnes per year) of mango and other fruit or vegetables, 70% of which are sustainably sourced within the next 3 years.
- Increase the processing yield from 40% to 60% in the next 3 years
- In the next 5 years reduce the food loss by:
  - 70% in the growing and post harvesting stages
  - 50% in processing
  - 20% in distribution



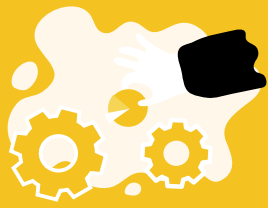



# SET BUSINESS MODEL

Defining a new business model  
to deliver the business strategy



## BM.3

Gather  
additional data  
on operational  
performance

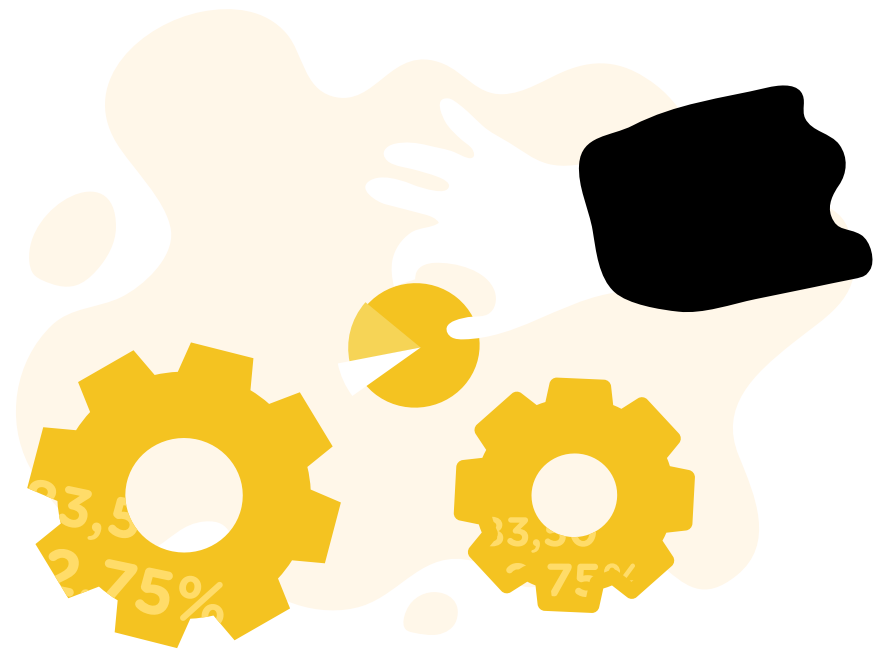

## BM.3 Gather additional data on operational performance

### TIPS & TRICKS

#### USE DOCUMENTATION AVAILABLE ON SITE TO GATHER DATA ON OPERATIONAL PERFORMANCE

Most of the data needed to quantify the operational performance can be gathered on site. Some of the questions that you should ask the production management in order to obtain the necessary data are:

- Do any accounts records exist for raw material purchases?
- Do any production records exist? Use these to find out how much raw material is actually used, rather than how much is ordered and delivered. Try quantifying each raw material used separately.
- Do any waste transfer notes or waste disposal invoices exist? This can be used to find out how much solid waste has left the site.

- Do any records exist about packaging purchases and properties?
- Is information on energy and water usage available?

If you do not have all the data available to assess the operational performance, approach the accounting department. The accountants may have records that provide details of materials and services bought, product sold and waste disposal costs. Additionally you can contact the suppliers of raw materials, packaging, and waste disposal companies in order to acquire the required data. As a last resort you can also use the data available at the company (invoices, bills, reports, records) in order to make an estimation of a KPI if direct information does not exist.

#### USE SOURCES OF DATA ALREADY AVAILABLE

Life Cycle Assessment (LCA) is used for gathering data and making quantitative assessment on environmental performance of a value chain. However conducting a LCA is a research and data intensive process. Conducting desk research on completed LCA studies for specific food products or categories might give you a sufficient understanding on life cycle impacts of your targeted company. If more detail is required there are several sources of data and guidelines that can be useful. Below you will find sources of information about LCA, environmental KPIs, environmental management and best available techniques for minimizing environmental

impact in the food industry.

- Eco-Management and Audit Scheme - EMAS is an environmental management tool developed based on ISO 14001:1996, international standard on environmental management. The tool is currently used by approximately 4,500 organizations at over 8,000 sites for environmental assessment and improvement of environmental performance. Sector specific guidelines can be found at the EMAS website: [http://ec.europa.eu/environment/emas/index\\_en.htm](http://ec.europa.eu/environment/emas/index_en.htm)
- Best Available Techniques References Documents on Food, Drink and Milk Industries – provide detailed information

- about environmental KPIs used in the food industry sorted by each processing operation used in the processing of food. Benchmarks on many KPIs are also provided, which are periodically updated. Available at: <http://eippcb.jrc.ec.europa.eu/reference/>
- Product Environmental Footprint Guide – the PEF Guide provides guidance and methodology for conducting a LCA and is based on ISO 14040/44:2006. The PEF Guide is supplemented by documents specific to product and organisational groups. Available at: <http://www.pef-world-forum.org/>
- ENVIFOOD – this protocol provides guidance on LCA specific to the

## BM.3 Gather additional data on operational performance

food industry. Important KPIs are listed and methodology for data acquisition is thoroughly covered. Available at: <http://www.food-scp.eu/>

- SENSE-tool – Easy-to-use online tool to calculate food product environmental impact. A 14-day, free licence is available at: <http://www.senseproject.eu/>
- Sustainability Consortium – offers data and reports on environmental KPIs across major industry sectors covering the whole value chain. The services and products of the Sustainability Consortium can be accessed through a yearly membership fee or licensing agreement. Available at: <http://www.sustainability-consortium.org/>

### **PRIORITIZE DATA GATHERING FOR PRODUCTS WITH HIGH THROUGHPUT**

Generally food companies manufacture several different products on one or multiple product lines. You can maximize the cost-to-benefit of the data gathering activities by focusing on the product that has the highest throughput. The results can often be extrapolated to cover other lines and products.

## BACKGROUND INFORMATION

### **Operational KPIs**

Some commonly used KPIs in the food and drink industry are listed in Table 6. The nature of the food and drink processing markets makes it difficult to provide a set of indicators that fits the whole industry. The suggested KPIs will give you a useful starting point, from which you can develop indicators suited to the company.

### **Environmental KPIs**

Environmental KPIs are used to quantify the environmental impact of a company or a value chain. KPIs that are applicable for the food industry generally include parameters to quantify: air emissions, waste water, solid waste, energy, utilities and other specific operational materials.

### **Social sustainability KPIs**

Social performance indicators can be categorized according to the value chain stakeholders affected by a company's operations. The categories include: Employees, Local community, Society, Consumers, and Other value chain actors (UN Environment/SETAC, 2009). Important stakeholder and social impacts in the agri-food value chain are shown in Figure 10. The indicators were developed by Agresearch, New Zealand (2009), using methodological approaches presented by UN Environment (UN Environment/SETAC, 2009), Labuschagne and Brent (2006) and Klosch et.al. (2008).

### **Benchmarking**

Apart from tracking the progress towards the strategic goals, KPIs can also be used for benchmarking. Benchmarking was introduced earlier in this supplement as a tool for identifying opportunities for eco-innovation. It is also an excellent way to assess where the

## BM.3 Gather additional data on operational performance

KPI	Unit	Description	Reflects on	Desired result
Water consumption	m <sub>3</sub> /tonne of product	Total water use on site, excluding cooling water and extracted and returned to source	Total volume of water consumed in any given time period (week, month, year)	Low levels
Process water	m <sub>3</sub> /tonne of product	Water used in processing operations, including that used as raw material (ingredient)	Volume of water used in any given time period to produce a normalised unit of production	Dependent on the particular product
Product rework	% (by number of items)	Percentage of finished goods (number of items) that have to be reprocessed in some way (if applicable) one or more times	Level of rework – related to inefficiency or very high quality standards	Low levels – high levels are generally bad
Total product yield	% (by weight)	100% x tonnage of saleable goods divided by total tonnage of all goods produced	Overall effectiveness in making saleable product	High levels
Process energy (specific activities)	kWh/tonne of product	Amount of energy used in separate specific manufacturing processes (eg bottling lines, ovens, mixing vessels) per unit of production	Process energy use by different activities (allow this to be tracked independently) requires high levels of process control and monitoring equipment	Low levels
Total raw material use	Tonnes/tonne of product	Relative quantity of raw material consumed in a given time period, including all packaging but excluding fuel and water (unless water is also a main ingredient/raw material)	Allows raw material consumption to be tracked over time, regardless of the level of production output	Low levels are generally good, but varies according to product

Table 6. Commonly used operational KPIs in the food industry (WRAP, 2013)

# BM.3 Gather additional data on operational performance

company stands compared to other businesses in the sector. It is used to find specific areas for improvement such as high energy use, low processing yields or extensive use of water. Unfortunately benchmarking data is not readily available and is often quickly

outdated. Table 7 gives an example of benchmarking data in the European market for total product yield, a very important KPI. Where possible, you should always try to seek out local, up to date benchmark data.

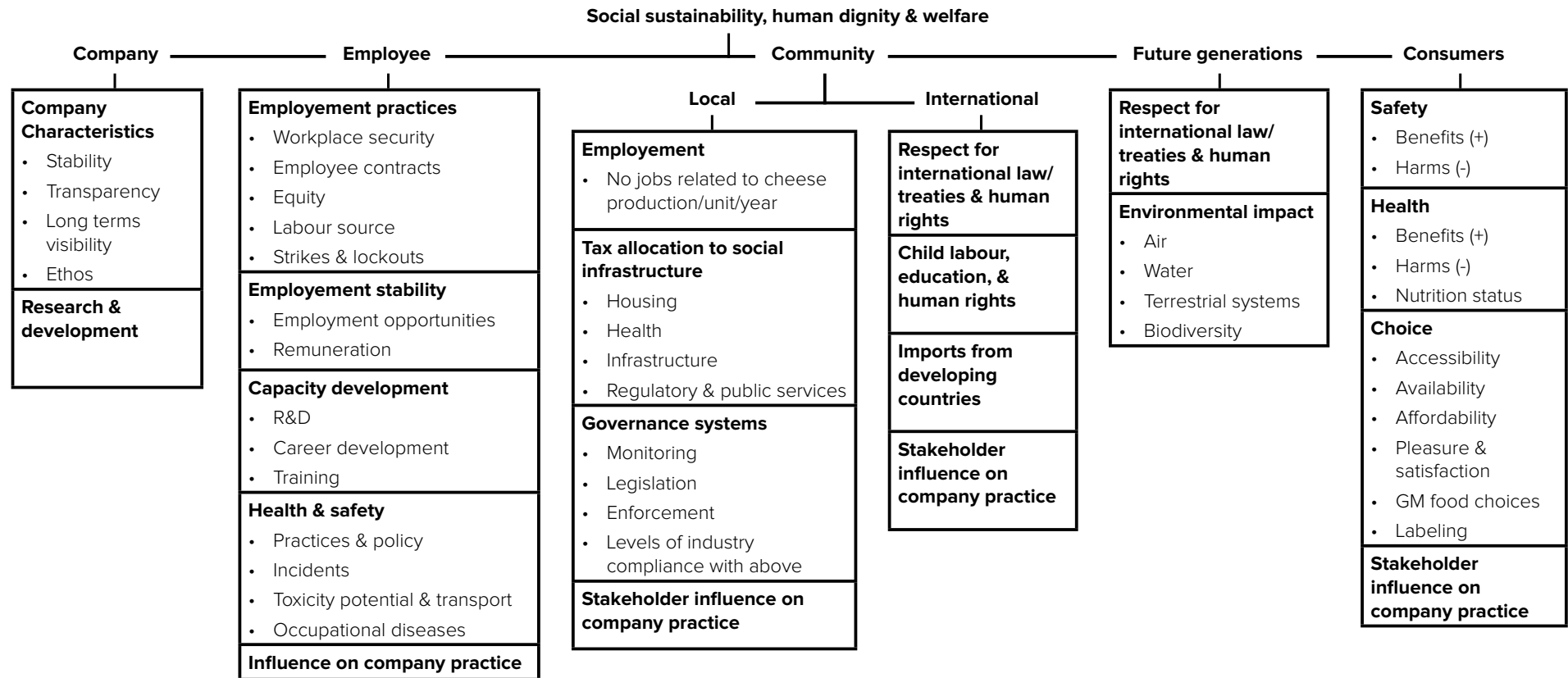

Figure 10. Example of social indicators in the agri-food value chain (Agresearch, 2009)

## BM.3 Gather additional data on operational performance

Production process	% of raw material in final product
Fish canning	35-70
Fish filleting, curing, salting and smoking	25-50
Crustacean processing	40-50
Mollusc processing	50-80
Milk, butter and cream production	99
Yoghurt production	94-98
Fresh, soft and cooked cheese production	10-15
White wine production	70-80
Red wine production	70-80
Fruit and vegetable juice production	50-70
Fruit and vegetable processing and preservation	70-95
Vegetable oils and fats production, i.e. crude vegetable oil, protein rich meal, lecithin and fatty acids from oilseeds	30-60
Maize starch production	62.5
Maize starch production (including animal feed)	99
Potato starch production	20
Maize starch production (including animal feed)	30-35
Wheat starch production	50
Maize starch production (including animal feed)	99
Food and animal feed production from sugar beet	25-50

### References

- WRAP (2013). Business Resource Efficiency Guide: Self-assessment Review for Food and Drink Manufacturers. Available from: [http://www.wrap.org.uk/sites/files/wrap/WRAP\\_Food\\_Drink\\_Manufacturers.pdf](http://www.wrap.org.uk/sites/files/wrap/WRAP_Food_Drink_Manufacturers.pdf)
- UN Environment/SETAC (2009). Guidelines for Social Life Cycle Assessment of Products. Available from: [http://www.unep.fr/shared/publications/pdf/dtix1164xpa-guidelines\\_slca.pdf](http://www.unep.fr/shared/publications/pdf/dtix1164xpa-guidelines_slca.pdf)
- Labuschagne C., Brent, A.C. (2006). Social indicators for sustainable project and technology life cycle management in the process industry. *Int. J. LCA*, 11(1), 3-15.
- Kolsch, D., et al. (2008). How to measure social impacts? A socio-economic efficiency analysis by the SEEBALANCE® method. *International Journal of Sustainable Development*, 11(1), 1-23.
- Agresearch (2009). Social Life Cycle Analysis (S-LCA): Some Methodological Issues and Potential Application to Cheese Production in New Zealand
- European Commission (2006). Integrated Pollution Prevention and Control: Reference Document on Best Available Techniques in the Food, Drink and Milk Industries

Table 7. Percentage of raw materials (by weight), which end up in the final product in selected processes (European Commission, 2006)



## BM.4

Generate  
business model  
concepts at the  
big picture level

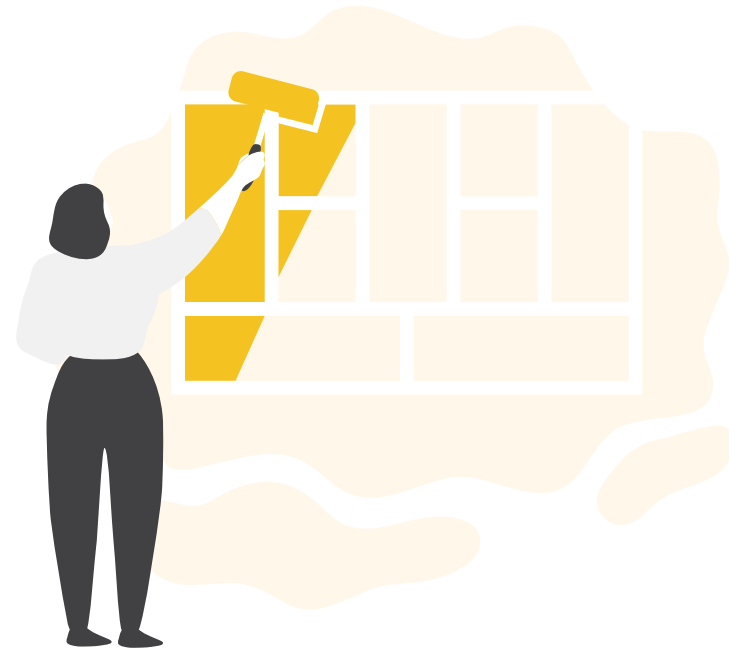

# BM.4 Generate business model concepts at the big picture level

## TIPS & TRICKS

### BRIDGE THE GAP BETWEEN PRIMARY PRODUCERS AND CUSTOMERS

There may be an opportunity to find business model solutions to bridge the gap between farmers and consumers. This will allow farmers to obtain higher prices for their crops and also provide the consumers with the experience of being closer to the farmer. In Indonesia, Cassia COOP is a cinnamon processing and trading company with a vision *“To export cinnamon products and patchouli oil from Indonesia while removing middlemen from the supply chain. As a result linking farmers with end-users and vice versa in order to create transparency and interdependency. Creating a fair*

*and efficient supply chain while having a sustainable positive impact in Sumatra, Indonesia.”*

The company collaborates with several NGOs to give farmers training in sustainable farming methods and make sure they comply with certification criteria. Cassia COOP processes and distributes cinnamon products on behalf of the farmers by guaranteeing them a good price for their cinnamon as well as a percentage of profits when their products are sold. Sustainability and transparency is a key feature of their business model and the company has made positive environmental and social impact in the region. Economic sustainability is also improved by this type of business model as a larger propor-

tion of the profit is shared between farmers and processors, rather than traders and distributors, while end users get a better price. More information can be found at: <http://www.cassia.coop/>

### COMBINE SERVICES WITH GOODS TO FULFIL CUSTOMER NEEDS

An emerging business model in the food and drink processing sector is offering subscription based services rather than goods, directly to the consumer. NatureBox is a company in the United States that has identified the consumer need for healthier snacks in that market. It has developed over 120 different varieties of healthy snacks to cater to that

need. Customers subscribe to a service where they choose the quantity and frequency of snacks delivered to their home. The company is doing particularly well in areas where there is no access to supermarkets selling sustainable and healthy food. In 2013 the company experienced 2000% growth. More information can be found at: <https://naturebox.com/homev2/>

### ALTERNATIVE PROTEIN SOURCES

There are several different alternatives for meat products on the market, developed and marketed for people that do not consume meat (vegetarians, vegans). However there is an increased concern about eating meat (particularly red meat) among

people who enjoy eating it. The concern is mainly due to the very high environmental impact of meat as well as health concerns identified in the recent report from the International Agency for Research on Cancer, the cancer agency of World Health Organisation (IARC, 2015). Some food companies have therefore started creating innovative products from alternative protein sources that are just as tasty and have just as good texture as meat. Pulses (beans, legumes) are often used as a protein source, but there are various other alternative protein sources such as insects and worms. The key for successful companies was understanding the consumer needs, which was a tasty, protein-rich meal, rather than eating meat.

# BM.4 Generate business model concepts at the big picture level

## LEARNING CASE STUDY

### Food for Progress

Food for Progress is a Swedish company with the goal to create tasty, nutritious and climate-savvy food that can feed all people on earth. They want to drive the development towards sustainable food through creating unique soy based products and actively trying to change unsustainable consumer behaviour, such as eating too much meat. In 2015 the company was awarded the prize by the Swedish Food Industry Association for being the most innovative company and contributing significantly to the development and competitiveness of the Swedish food industry.

### Business model #1: Cooperative business model

In order to achieve their strategic goals, the Eco-innovation project team at Mango Pulp Company have generated a new business model idea based on cooperation with farmers, financial institutions as well as universities and technology suppliers. The objective is to produce a variety of premium products with improved sustainability and competitiveness and to valorise the by-products. Figure 11 is a graphical representation of the cooperative business model of Mango Pulp Company.

Figure 11. Key partners in achieving a sustainable business model.

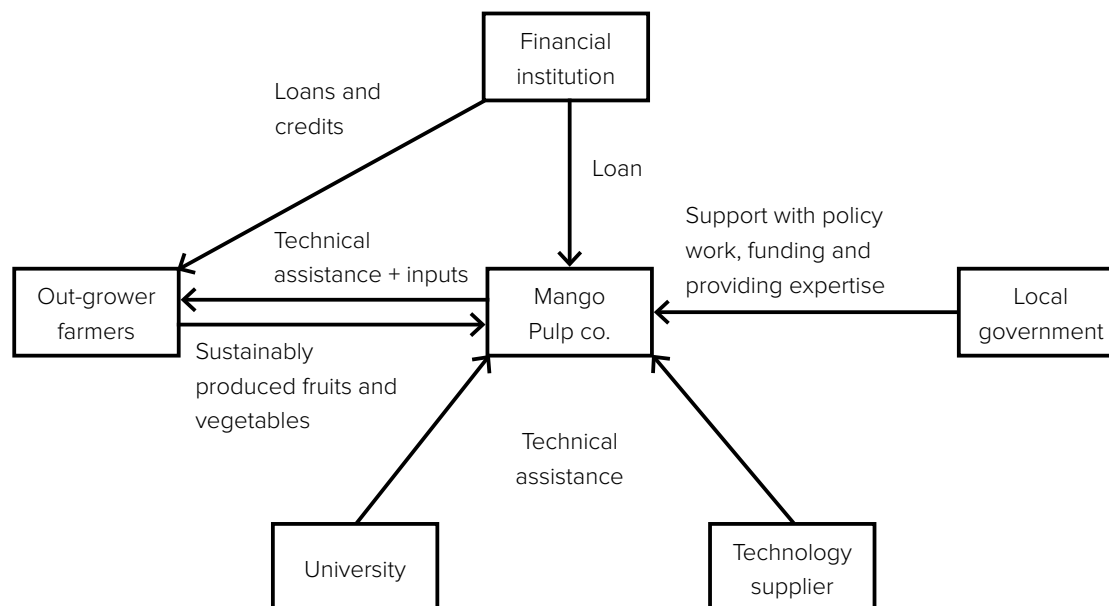

## BM.4 Generate business model concepts at the big picture level

The **value proposition** captures three of the main aspects of the new business model:

1. The new products are made using sustainably sourced raw materials
2. Improved quality of the finished products, and
3. Diversified operations to other fruits and vegetables to make better use of personnel and equipment.

During the sustainability assessment, it was concluded that the highest environmental and social impacts came from the production stages of the value chain. The company has therefore put effort into promoting conservational agriculture, which is based on minimal soil disturbance, permanent soil cover, and annual crop rotation. In practice, this means that Mango Pulp Co. has engaged in a **partnership** with the farmers where the company is now procuring all fruits and vegetables and processing them as well as providing technical assistance. In return, the farmers are following the sustainable farming methods required by Mango Pulp Co., have mango as a main crop, and only sell their produce to the company.

The company has applied for an organic label after **securing a supply of sustainably** grown mango and replacing calcium carbonate for ripening purposes. Ripening mangoes with ethylene gas in an airtight room resulted in high quality mangoes and uniformly ripened mangoes. Ethylene gas for ripening fruits is approved by the organic regulations in most countries.

Diversifying into other fruits and vegetables created more opportunities to enter **new markets**, such as dried fruits, fruit and vegetable juices, jams, pickles, and healthy snacks. The company has become a supplier to the public sector (hospitals and schools)

thanks to sustainable public procurement policies. The company is also supplying restaurants and hotels in order to reach their goal of increasing sales of processed fruits and vegetables. The new products are packaged in customised packaging solutions for each customer to support sustainable consumption and eliminate waste.

Since Mango Pulp Co. was new to some of the variations in production needed for these products, technical universities and equipment suppliers have been helpful in developing them and optimizing the processing line to minimise water and energy consumption. They also provided assistance when valorising by-products like skins, seeds, and other parts of the plant not used in the product. Some options that are still being considered include selling mango skin to cosmetic companies, drying of overripe fruits and vegetables, making flour out of mango seed or investing in a biogas digester in order to make biogas and organic sludge that could be used by farmers as fertilizers.

New **packaging solutions** were developed with the help of an R&D partner and customized to each customer segment. Fruit and vegetable pulp for the consumer market is now packaged in appropriately sized re-sealable, recycled (and recyclable) plastic bags. The plastic bags are made of a special PA/PE polymer and have a significantly lower weight and volume than tin cans. They are suitable for vacuum or modified atmosphere packaging for increased shelf-life of products while allowing significant energy savings during processing. For instance, the high energy use for can sterilization is now completely mitigated. Products intended for hospitals, schools, hotels and restaurants are packaged in much larger bags equipped with a solution to dispense of the content to consumer-tailored portions. Mango Pulp Company provides the dispenser in return for

## BM.4 Generate business model concepts at the big picture level

a commitment from the customers to purchase their products. Both packaging innovations aim to eliminate a lot of the post-processing waste generated in the value chain of Mango Pulp Co.

The implementation of this new business model would not have been possible without financial support. **Investments** had to be made in agricultural production, processing equipment, new technologies, product development and certification. For instance, it takes 4 years after planting the new grafted mango trees before the first harvest is ready and an additional 3 years before the maximum yields are achieved. Most farmers would not have a source of income during these years as new higher quality grafted trees are planted.

The Mango Pulp Co. itself needed: financial resources to develop new processing lines for products not currently manufactured; new technologies for valorisation of by-products; and new packaging and dispensing solutions. The local government has been a valuable partner that provided incentives for sustainable development and creating employment in the region. As a part of their National Development Plan, the local government co-financed the shift to out-grower schemes. The contact and access to the government funds have been negotiated and facilitated through the Service Provider organization.

There are other **key partners** not specifically represented in the Business Model Canvas that played an important role in helping the company become more sustainable. For instance, Mango Pulp is cooperating with a distribution company that guarantees fast deliveries in chilled conditions in order to maximize the quality of fruits and vegetables. A certification body has also been a key partner because getting certified and labelled as sustainable was crucial to

entering international markets. The costs associated with certification will be covered by securing more revenue from the expected increased product sales after meeting certification standards. This is a long process and communication and collaboration with the certification body was needed. The company expected to get the “100% organic” label 3 to 4 years after the initiation of the new business model and strategy.

The alternative business model for Mango Pulp Company represented in a business model canvas blow.

# BM.4 Generate business model concepts at the big picture level

## LEARNING CASE STUDY OF BUSINESS MODEL CANVAS

<b>Key Partners</b> <i>Farmers</i> <i>University</i> <i>Financial institutions</i> <i>Technology suppliers</i> <i>Transporters</i> <i>Certification body</i> <i>Packaging suppliers</i>	<b>Key Activities</b> <i>Fruits and vegetable processing</i> <i>Research and development</i> <i>Training on conservation agriculture for farmers</i> <i>Value addition to waste</i> <i>Acquire organic label</i>	<b>Value Propositions</b> <i>High quality, good tasting, sustainably sourced packaged fruit and vegetable products</i>	<b>Customer Relationships</b> <i>E-marketing</i> <i>Personal contact</i>	<b>Customer Segments</b> <i>International wholesales and retailers</i> <i>Local retailers</i> <i>Animal feed producers</i> <i>Cosmetic company</i> <i>Hospitals</i> <i>Schools</i> <i>Restaurants</i> <i>Hotels</i>
	<b>Key Resources</b> <i>Trained farmers</i> <i>Biomass</i> <i>Processing facility</i> <i>Creative and experienced staff</i>		<b>Channels</b> <i>Sales force</i>	
<b>Cost Structure</b> <i>Labour</i> <i>Ingredients and processing aids</i> <i>Water</i> <i>Cleaning chemicals</i> <i>Wastewater treatment</i> <i>Natural gas</i>		<i>Packaging</i> <i>Maintenance of equipment and facilities</i> <i>Rent</i> <i>Investment in equipment and infrastructure</i> <i>Certification</i> <i>Transportation</i> <i>Electricity</i>	<b>Revenue Streams</b> <i>Sales of packaged fruits and vegetable products</i> <i>Sales of secondary products such as peel and stone to the cosmetic and animal feed industry</i>	

# BM.4 Generate business model concepts at the big picture level

## BACKGROUND INFORMATION

### References

Veronique Bouvard et al. on behalf of the International Agency for Research on Cancer Monograph Working Group (2015). Carcinogenicity of consumption of red and processed meat. The Lancet Haematology, Volume 3, Issue 1

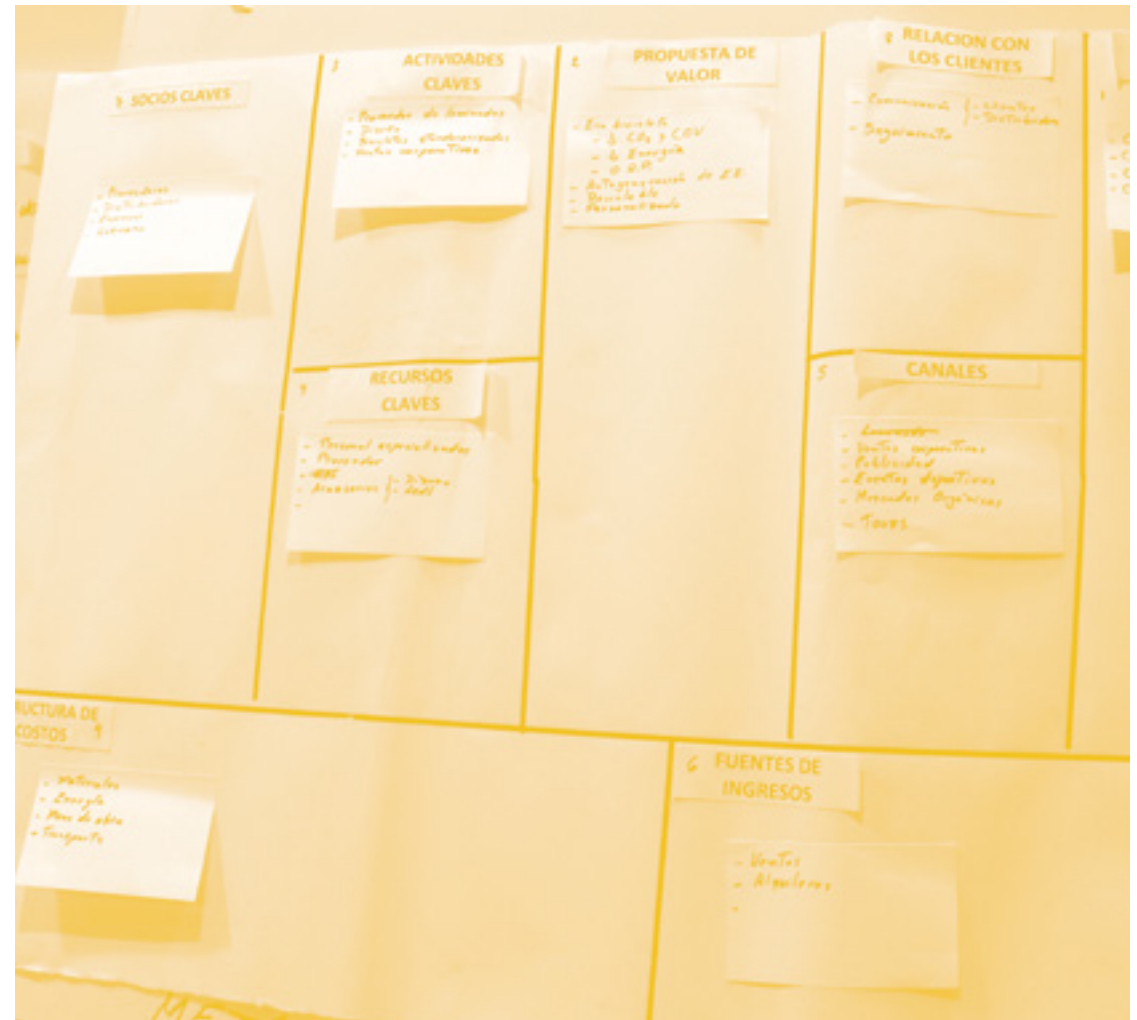





## BM.5

Generate ideas  
for the customer  
segments block



# BM.5 Generate ideas for the customer segments block

## TIPS & TRICKS

### USE CUSTOMER SEGMENTATION TO HELP IDENTIFY CUSTOMER GROUPS TO TARGET WITH SUSTAINABLE PRODUCT OFFERINGS

The two fundamental questions to take into account are:

- *Which customer segment(s) should we target with our products and services?*

You might consider business-to-business customer segments, such as: other food companies, hotels, restaurants, airlines, hospitals, government or private companies. Alternatively, if your strategy is focused on business-to-consumer markets then you should consider specific types of consumers, such as: the elderly; infants; or school children. You may also wish to refine

your customer segments further by targeting specific occasions, such as: breakfast time; lunch away from home; snacks; or office food.

- *What are the needs and requirements of our target customer segments?*

A proper assessment of the needs and requirements of the target customer segments is very important to guarantee market success. Do they require premium products, convenience products, long shelf-life, affordable products, or healthy options? In the eco-innovation manual some examples are provided for how consumer requirements can be assessed. This includes: interviews, electronic surveys, focus groups, or telephone interviews.

## BACKGROUND INFORMATION

Two end markets exist for food and drink products: the consumer market (or the mass market) and the food-ingredient market. A food-ingredient company will manufacture products that are generally a few processing steps away from being ready-to-eat, then sell them in bulk to other companies that will add value to those ingredients. In contrast, companies that manufacture consumer-ready products will place them on the mass market through a distributor such as retailers or wholesalers.

Recently, with the rise of the retail sector, many food and drink processors are providing processing services instead of selling a product. Retailers are mostly interested in this service for the creation of private labels that can increase customer loyalty. As for the food processors, they will settle for a lower margin for the benefit of securing a market without the need for expensive marketing activities, such as branding and promotion.

## BM.6

Generate  
marketing ideas  
for the value  
proposition block



# BM.6 Generate marketing ideas for the value proposition block

## BACKGROUND INFORMATION

The *People, Planet, Profit (PPP)* template is used to generate creative, value proposition ideas for Mango Pulp Co. You can use the *PPP* template to help you find ways to modify the requirements of the product so as to create new benefits for the business, the environment and the customer at the same time.

The requirements listed in the diagram can be used to generate ideas for a new value proposition. Ideas can be generated by thinking about how each requirement can be “pushed” towards the so called tri-synergy point where the requirement benefits all three stakeholders involved. Mango Pulp Co. already has a high quality product that is benefiting the company economically (Profit), but also the consumers (People). The requirement is thus lacking environmental benefits in order to be in the tri-synergy. The idea generation is therefore focused on improving the environmental sustainability performance of the product. Some sustainability issues were identified during the Life Cycle Thinking exercise in the SET STRATEGY phase. These can now be revisited in order to help generate new value proposition ideas for a new business model.

Based of those requirements, the following two additional business models were proposed:

**Business model 2** – Collaborate with local government and farmers to create an eco-park on farms in the proximity of Mango Pulp facilities. Visitors will be able to get a better insight in the value chain of the Mango Pulp Company through guided tours. This business model focuses on building relationships between farmers and consumers in order to increase profitability across the value chain. Sales of Mango Pulp products are supplemented by eco-tourism activities and profits are shared with farmers involved in the eco-park.

**Business model 3** – Adopt a hybrid organisation business model in which one part of the company is engaged in not-for-profit activities. These not-for-profit activities will include social and environmental projects for the local community, such as providing scholarships for farmer families. This aspect of the company will also help the company to increase sales in the domestic and export markets and attract skilled workforce to the company.

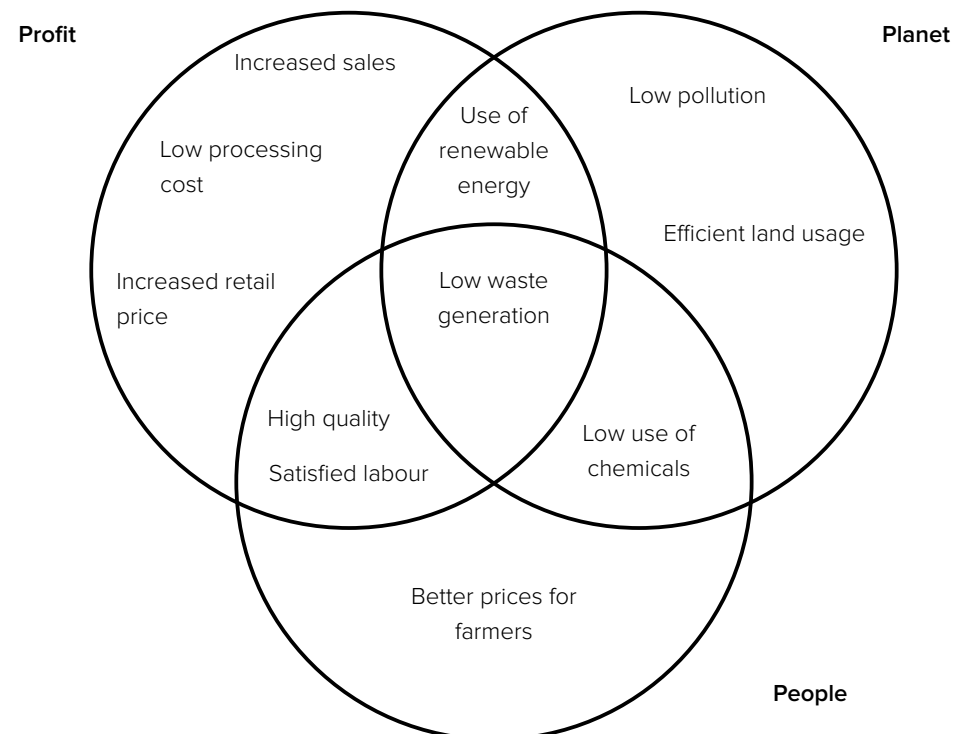

## BM.7

Generate  
technical ideas  
for the value  
proposition block



## BM.7 Generate technical ideas for the value proposition block

### SOME EXAMPLES OF ECO-INNOVATIVE VALUE PROPOSITION IN THE AGRIFOOD VALUE CHAIN

- Products from alternative protein sources – This approach can be applied to companies in the meat and dairy sectors. The value delivered to the consumers can include nice tasting, novel, functional food that have a significantly lower sustainability impact compared to traditional meat and dairy products.
- Life cycle approach to choice of ingredients and process – Developing new products and processes in the food and beverage industry generally focus on attributes such as quality, taste, texture, appearance, nutritional

value and shelf-life when choosing ingredients and process technology. Adding life cycle impact as an attribute during the product and process developing stages might add value for consumers who are environmentally and socially aware.

- Eco-labels – Using eco-labels can help to assure consumers that the products they are buying have relatively low environmental impacts. This is particularly important in markets where consumers are willing to pay a higher price for products that are more environmentally sustainable.
- Zero food loss and waste products – The increase in efficiency in the value chain by

elimination of food loss and waste could have several benefits for the consumer. For instance, the price of the product could be decreased while the availability of food would increase. Smart product and packaging design could also eliminate waste and waste disposal effort for the end consumer.

- Increased transparency and traceability – This could increase consumer trust in food quality and safety standards.
- Designing products and packaging to minimize impacts in consumer and end-of-life phase – Food bought and not eaten by consumers is an unnecessary cost that could be reduced by proper product and packaging design. Some

tips for reducing this waste include: selecting appropriate portion sizes for different customer segments; proper expiration date labelling differentiating when food is at peak quality and when it is still safe to consume (labelling regulation can be a limiting factor); choosing packaging solution that will extend the shelf-life of the product while reducing environmental impact; communicating clearly to the consumer how the food should be stored.

- Being beyond compliance with international and export standards for food quality, safety and environmental management – This would deliver high

quality and safe food products to the consumer while reducing risks for the company. The risks mitigated include new regulation affecting the company and risks of food borne illness outbreaks.

- Product diversification – Diversification increases the availability of food products for the consumers and enables the company to enter new markets segments.

# BM.7 Generate technical ideas for the value proposition block

### CONSIDER DEVELOPING AND MARKETING PRODUCTS WITH POSITIVE IMPACTS FOR VALUE CHAIN ACTORS

Consider developing products that offer clear sustainability benefits and try to communicate those positive impacts to the consumers. Some examples of this include:

- Using less additives and processing aids (e.g. only using natural ingredients)
- Avoiding ingredients that negatively affect human health (e.g. reducing salt content, fat content or sugar content)
- Using ingredients with less impact on the environment (e.g. many manufacturers have stopped using palm oil where a suitable

- substitute was available)
- Using organic raw materials (materials produced without use of artificial chemical aids)
- Complying with social responsibility standards (e.g. fair wages for employees and fair prices to farmers)

## LEARNING CASE STUDY OF 9 WINDOWS OF THE WORLD

An example of generating technical ideas for a value proposition using the *9 Windows of the World* template for the Mango Pulp Company is shown below:

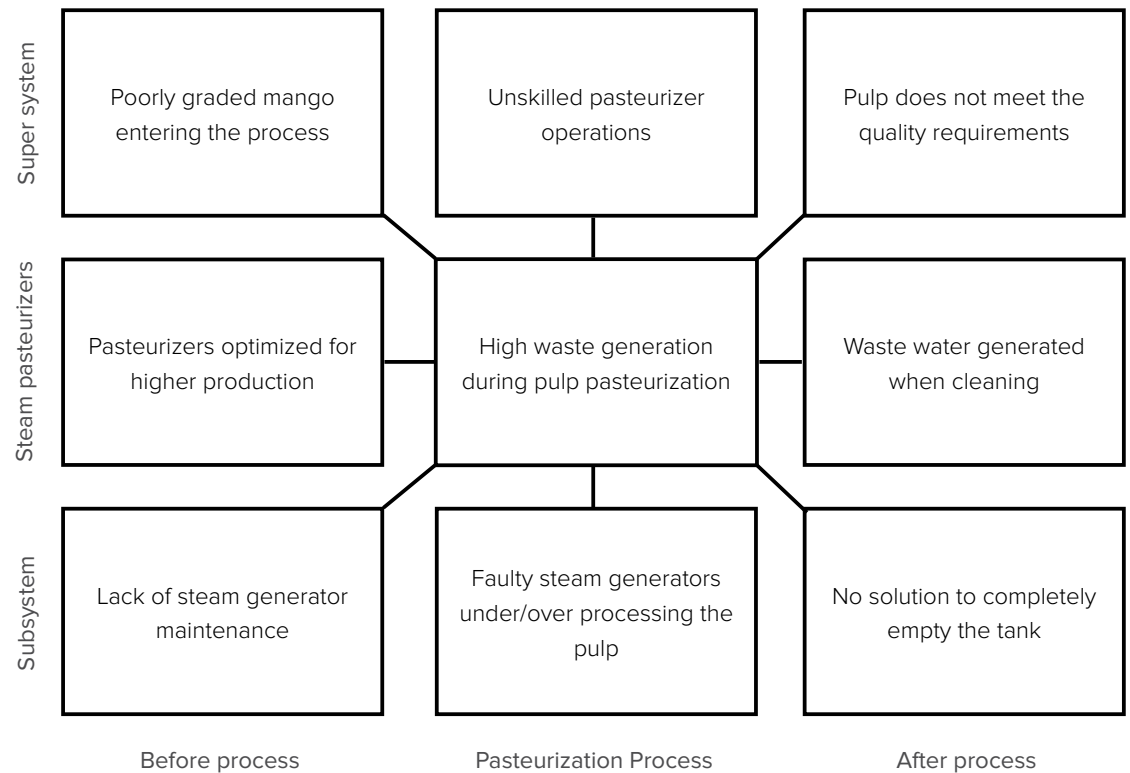





## BM.8

Generate ideas  
for the channels  
block



# BM.8 Generate ideas for the channels block

## TIPS & TRICKS

### DEVELOPING A MARKET-ING STRATEGY

Key questions to discuss with the company to help formulate a marketing strategy include:

- Are your customers interested in sustainability performance? Or are they simply interested in the potential financial or functional benefits of eco-innovative products such as reducing utilities consumption and waste? In this case marketing should be done based on those other product attributes.
- Do recognized eco-labels or sustainability standards exist that are relevant for your markets? Are there any competitors in the organic products market? N.B. In the agri-food value chain, a large number of Eco-

labels exist with different requirements in different countries. It is important to evaluate the specific requirements for each market.

- Would there be business benefits from communicating your sustainability message to other stakeholders such as possible financiers, local governments or environmental lobby groups? Costs associated with CO<sub>2</sub> emissions or waste water can be communicated in case there are fees associated with the release of GHG or waste water.

### LOOK FOR OPPORTUNITIES FOR IMPROVEMENT IN PACKAGING AND DELIVERY

The transportation phase, including packaging and delivery to the customer or consumer, can offer a variety of opportunities for eco-innovation, such as:

- Reducing the quantity of packaging or use of biodegradable packaging for products where packaging has a significant environmental impact e.g. fruits and vegetables;
- Improving logistics and transport e.g. sea freight versus air freight or truck;
- Reducing food losses during distribution and commercialisation.

### USE OF COLD CHAINS

Using a cold chain means keeping perishable foods under low temperatures without interruption, from post-harvest activities all the way until the product reaches the final consumer. For certain foods, maintaining the cold chain can significantly increase the quality and shelf-life and in turn reduce waste and loss. Care has to be taken to ensure that food is chilled to the correct temperature and that appropriate refrigeration/freezing technology is used. This choice will greatly depend on the type of food and sophistication of the cold chain. Some companies in developing countries will not have the access to warehouses and transportation with sophisticated refrigeration

systems. Instead simpler and inexpensive refrigeration technologies should be considered. Some guidelines for choosing the appropriate cold chain technology can be found at: <http://www.fao.org/3/a-ax746e.pdf> and <http://www.postharvest.org/Use%20of%20cold%20chains%20PEF%20white%20paper%2013-03%20final.pdf> Cold chains are often perceived as expensive and energy intensive, which can make companies reluctant to invest in them. However the reduction in food loss due to the cold chain will increase the amount of products reaching the market and will generally offset the environmental impact of the energy used for refrigeration.

## BM.8 Generate ideas for the channels block

### BACKGROUND INFORMATION

Processing companies within the agri-food value chain generally work in a business-to-business environment, whether it is a distributor or another food company that is the customer. Therefore, in many cases the clients have account managers assigned to them to maintain a good relationship. When it comes to the physical channels of delivering the products to the consumer, cold chains are important in the agri-food value chain as many foodstuffs are highly perishable





## BM.9

Generate ideas  
for the customer  
relationships  
block



# BM.9 Generate ideas for the customer relationships block

## TIPS & TRICKS

### CONSIDER SOLUTIONS FOR IMPROVING TRANSPARENCY AND TRACEABILITY

Increasing supply chain transparency and product traceability to customers and outside stakeholders have become an important business driver for companies (2015 State of Green Business Report). Tracking their supplies is not a completely new practice but the development of new technologies has become a key enabler to account for environmental and social impacts of their material and products and make this information available to consumers. This also pushes companies to think about how they can innovate in their practices and business models to enable them to demonstrate compliance with the increasingly stringent sustainability standards. Real Co. operates

with the vision of being the first global single origin food company. It sells agricultural commodities such as salt, sugar and rice from individual farms and producers in developing economies to retailers in the US. Its model is based on cutting out the middlemen and sharing the benefit with producers and consumers. Consumers benefit from sustainable products at more affordable prices and can also learn about the origins of the product through the stories of the producers placed on the final packaging and the company website. Real Co. pays better prices to farmers. The farmers in turn are investing in sustainable practices and new facilities that lead to better quality products. <https://www.greenbiz.com/article/company-could-set-new-bar-transparency-food>

### USE CONSUMER FEEDBACK TO GENERATE NEW IDEAS

Long-term contact with customers in the agri-food value chain can be achieved by providing information about the sustainability aspects taken into account during production and manufacturing of the product. This content can be delivered to customers through a website, social media or on the packaging. Online contact can allow the company to easily communicate with consumers and accept suggestions for improvement, which may lead to new ideas for eco-innovation.

## BACKGROUND INFORMATION

Companies in the agri-food value chain are increasingly open about their operation and are implementing transparency and traceability policies. 'Transparency' refers to disclosure of information about rules and practices throughout the whole product value chain (Sage). 'Traceability' is the ability to trace all components in a food value chain to their origin (EC, 2007).

### References

Sage X3. Improving transparency in food manufacturing. Available from: <http://www.sagex3.com/~media/markets/erp33/resources/download/us/improving-transparency-in-food-manufacturing.pdf>

European Commission (2007). Food Traceability: Tracing food through the production and distribution chain to identify and address risks and protect public health. Available from: [http://ec.europa.eu/food/food/foodlaw/traceability/factsheet\\_trace\\_2007\\_en.pdf](http://ec.europa.eu/food/food/foodlaw/traceability/factsheet_trace_2007_en.pdf)

2015 State of Green Business (2015), Joel Mahower et al <https://www.greenbiz.com/report/state-green-business-report-2015>

## BM.10

Generate ideas  
for the revenue  
streams block



# BM.10 Generate ideas for the revenue streams block

## BACKGROUND INFORMATION

The primary revenue stream for most food and drink processing companies comes from the sales of their product to the customers downstream in the value chain. However, some innovative companies are no longer selling products and have instead moved to providing processing services for bigger companies or retailers.

### Industry example 2: PacMoore Products, Inc

PacMoore Products, Inc. a company that offers processing services including blending, spray drying, extrusion, heat treatment and packaging to other food ingredient companies further down in the value chain. Additionally, they also offer other services such as R&D, purchasing, storage and shipping. By switching the main revenue stream from sales of products to provision of services, PacMoore face less competition and no longer has to manage and market a portfolio of products. Also, because PacMoore now focuses on a core set of processing activities, it can invest in training and technology, which provides operational efficiency and quality benefits for the whole value chain.

Different strategies can be adopted with respect to pricing. Generically, there are two pricing strategies - sell large volumes with a small margin on each unit or make a large margin on each unit and settle for lower volumes. Companies in most markets are better off if the market is balanced i.e. where some companies compete on price and others on other competitive advantages (such as different taste preferences for different segments) (Perner n.d)

### Industry example 3: Upland Rice Millers – Uganda

Unlike other companies in Uganda, Upland Rice millers does not buy commodities from farmers but offers milling services to over 2,000 rice farmers. The farmers supply paddy rice to the company for processing and then sell it directly to customers. In addition to milling, the company allows also farmers to market their products under the company's brand. The company offers extra services to farmers that include free storage facilities and trainings to farmers and traders about the pre-harvesting and post handling practices that contribute to better yields (UN Environment Eco-innovation project)

### References

Perner, L., Food Marketing, Consumption and Manufacturing Available at: [http://www.consumerpsychologist.com/food\\_marketing.html](http://www.consumerpsychologist.com/food_marketing.html)



## BM.11

Generate ideas  
for the key  
resources block



# BM.11 Generate ideas for the key resources block

## LEARNING CASE STUDY

In order to solve the issue of variability and seasonality of the raw materials supply (mangoes) the Mango Pulp Company has decided to diversify its product portfolio to include products from other fruits and vegetables. The additional products are made from raw materials available in the off-season for mango.

## BACKGROUND INFORMATION

Food and drink processing is highly limited by unstable supplies of crops and other raw materials. The availability, variability and seasonality of raw material supplies can dictate both production volumes and product quality. In addition, the demand for specific food products is often seasonal as well (holidays, weather etc.) making it even more challenging for companies to manage the supply and demand. This issue is often solved by having extra capacity for peak seasons or by increasing storage capacity for products with longer shelf-life. The seasonality of supply and demand needs to be incorporated into the strategic planning process. Questions that are important to be considered are:

- How is the extra manufacturing or warehouse capacity being used in the off-season?
- Can some of the peak manufacturing be outsourced?
- What costs are involved for having unused capacity and large inventory compared to outsourcing?
- Considering these costs, what is the optimal combination of capacity, inventory and outsourcing in the supply chain?

Other key resources in the food industry include:

- Physical: Equipment, facilities, raw materials
- Intellectual: The processing know-how, patents, product formulations (recipes), brands
- Human: Personnel with key competences, e.g. raw material buyers, product developers, production staff, marketing and sales staff
- Financial: Capital in the company or access to capital

## BM.12

Generate ideas  
for the key  
activities block



# BM.12 Generate ideas for the key activities block

## BACKGROUND INFORMATION

Typical key activities in the food industry include:

- Procurement of raw materials - buyers who are procuring the raw materials are responsible for securing the materials with the required specifications for the best possible price
- Processing and packaging
- Food safety and quality control
- Product development
- Supply chain management and specifically cold chain management - Often need to ensure temperature controlled supply of highly perishable goods
- Marketing and sales - Achieving the requirements for certification and labelling schemes as well as customers' procurement policies is an increasingly important part of marketing and sales



## BM.13

Generate ideas  
for the key  
partnerships  
block



# BM.13 Generate ideas for the key partnerships block

## BACKGROUND INFORMATION

An important aspect of a food and drink processing company's business model in the agri-food value chain is its relationships with suppliers and customers. On the supply side, food is generally produced by small-scale farmers that sell their products on markets or to processors through agents. However, rural farmers and small-scale entrepreneurs lack both reliable and cost-effective inputs such as extension services, mechanization services, seeds, fertilizers, credit, and guaranteed and profitable markets for their output. 'Contract farming', sometimes referred to as an 'out-grower scheme', was introduced as a way to overcome this problem. Contract farming is an arrangement between the buyer (processor) and producer (farmer) where the processor is guaranteed to receive a certain quality and quantity of raw produce, while farmers are guaranteed a stable contract and price for their produce. The contract farming system should be seen as a partnership between agribusiness and food processors. To be successful it requires a long-term commitment from both parties.

Food and drink processing companies' relationship with customers has been influenced by the growth of the retail sector and distributors, who are an increasingly important partner for food processors. The retailers are closer to the end consumers and have a better insight into demands and the changing market trends. Collaboration with retailers can therefore help the food manufacturers increase their operational efficiency, get closer to the market and improve cost control. Furthermore, some food manufacturers are also offering processing and packaging services for products sold under the distributor's private label. This arrangement is beneficial for food manufacturers that want to focus

on large-scale production in order to increase cost-efficiency or do not have the resources to place products on the market under their own brand name.

Other partners include:

- **Equipment supplier:** equipment suppliers can help you in selecting the appropriate technological solution for your current problem. Many suppliers will also offer services such as training on the equipment, maintenance and technical support. Furthermore, collaborations with equipment supplier can lead to improved resource efficiency.
- **R&D partners:** when in-house expertise is not available, external R&D partners are often needed in order to conduct audits, improve operational performance, support product development, or conduct market research. The food manufacturer often contracts the R&D partner, but expert help can also be found through governmental or non-governmental funding schemes.
- **Ingredients supplier:** a good relationship with ingredient suppliers can help food manufacturers in selecting the most suitable ingredients and aids for their process at the best possible price.
- **Cleaning supplier:** both cleaning equipment and agents are needed in the daily operations of a food manufacturing businesses. Innovative cleaning solution can save cost and decrease environmental impact.
- **Transporters:** Cold transportation in particular is important in many agri-food markets in order to ensure the quality of the material inputs and product outputs.

## BM.13 Generate ideas for the key partnerships block

### StarShea Network

The StarShea Network was initiated through a project by PlaNet Finance, the global microfinance and development expert, and SAP, the world's leading provider of business software. These organisations teamed up to support women in northern Ghana to provide large volumes of high-quality shea products directly to large buyers, at fair trade prices. This is accomplished by providing women's groups with an innovative variety of services: training on shea production and business issues; access to microcredit; as well as software solutions and mobile phone technology for increased transparency and traceability of orders and revenues. You can find a video showing the network's innovative business model at <http://www.starshea.com/>.







## BM.14

Generate ideas  
for the cost  
structure block



# BM.14 Generate ideas for the cost structure block

## TIPS & TRICKS

### USE AVAILABLE ONLINE RESOURCES TO FIND COST SAVING SOLUTIONS

Finding the best solution to save costs can be a challenging task. There is often a need for both innovative managerial solutions as well as technology to effectively reduce costs. To help with this challenge, you can use online resource efficiency tools and resources, such as those provided by RECPnet (<http://www.recpnet.org/>, membership required) and WRAP (<http://www.wrap.org.uk/content/online-resource-efficiency-tools>). The WRAP resources include tools for improving raw material, water, packaging and energy efficiency. Among the tools is also the Resource Efficient Innovations Database (<http://reid.wrap.org.uk/>),

which provides numerous cost saving solutions for the food and drink processing industry.

### FOOD SAFETY COMES FIRST

Reducing costs should not compromise product quality, as aspects such as microbiological safety, colour, taste and texture of a product are key attributes for food safety and consumer satisfaction. However, the strategy to reduce costs is different if you have a “value-driven company” or a “cost-driven company”. A cost-driven company will focus on minimizing cost wherever possible by, for instance, increasing automation, energy efficiency or reducing wastes. A value-driven company is more

focused on creating and delivering value for the consumers and is generally less concerned about costs (Osterwalder & Pigneur, 2010). Given that most food stuffs are commodity products, it is not surprising that cost-driven companies are more common in the agri-food value chain than value-driven ones. In both cases, there are good opportunities for eco-innovation by increasing profitability along the value chain using a holistic approach for the reduction, reuse and recycling of input materials, water and energy, or better planning of production to meet the demand in cooperation with value chain partners.

## BACKGROUND INFORMATION

The bulk of the cost in an agri-food business comes from procurement of raw materials (including packaging), labour costs, and usage of utilities such as water, electricity, gas etc. Therefore, being resource efficient and eliminating waste where possible is key to saving cost in the food and drink processing industry. The largest waste streams can be divided into manufacturing material waste, waste packaging, water (water used in products, leakages etc.), effluents, cleaning agents, energy/heat losses, rejected products and wasted labour. When trying to improve resource efficiency, you should apply the waste hierarchy which ranks the waste management options according to sustainability impacts. Most preferable is waste prevention, followed by re-use, recycle, recover and the least preferable, disposal.

### References

Osterwalder, A., Pigneur Y. (2010) Business Model Generation: A handbook for visionaries, game changers and challengers

## BM.15

Evaluate the  
benefits



## BM.15 Evaluate the benefits

### LEARNING CASE STUDY

For the new cooperative business model of the Mango Pulp Company, some benefits include:

- Long-term partnership with farmers will help secure a stable flow of high quality raw materials
- Diversification to products from other raw materials will help with the cash flow problems during off season when mangoes are not available
- Reduced costs through better usage of waste materials
- Increased revenue from markets for sustainable fruit and vegetable products
- Elimination of chemicals toxic to human health will improve the quality of life of farmers and factory staff as well as reduce the risk of contaminated products reaching the consumer



# BM.16

Evaluate the costs



## BM.16 Evaluate the costs

### LEARNING CASE STUDY OF BUSINESS MODEL CANVAS

The cooperative business model for Mango Pulp Co. does not require a lot of direct investment, but the implementation effort is significant as the company lacks some of competencies required to implement the new model. The investment needed depends on the type of eco-innovation projects that will be implemented. For instance:

- A number of eco-innovation projects can be implemented with little investment by line-extension, i.e. using the same production line to produce other type of products.
- Larger investments might be required if new technologies are to be implemented. Such technologies can include new production lines for valorisation of by-products, or installation of a biogas digester for biogas production.

Conducting a performance gap evaluation, comparing the old and new proposed business models of Mango Pulp Co., showed that the company currently lacks some important requirements for implementing the new business model such as:

- The company does not currently have an organic label, which also requires cooperation with a certification body.
- The company does not have any in-house R&D capabilities, which will be required to develop valorised by-products and new customized packaging solutions.

A summary of the performance gap evaluation for the Mango Pulp Company is shown below.



# BM.16 Evaluate the costs

<p><b>Key Partners</b></p> <p>Farmers +          University          Financial institutions          Technology suppliers +          Transporters +          Certification body -          Packaging supplier - -</p>	<p><b>Key Activities</b></p> <p>Fruits and vegetable processing +          Research and development - -          Training on conversational agriculture for farmers          Value addition to waste -          Acquire organic label -</p>	<p><b>Value Propositions</b></p> <p>High quality, good tasting, sustainably sourced packaged fruit and vegetable products</p>	<p><b>Customer Relationships</b></p> <p>E-marketing - -          Personal contact +</p>	<p><b>Customer Segments</b></p> <p>International wholesales and retailers          Local retailers          Animal feed producers          Cosmetic company          Hospitals          Schools          Restaurants          Hotels</p>
<p><b>Key Resources</b></p> <p>Trained farmers          Biomass +          Processing facility +          Creative and experienced staff</p>			<p><b>Channels</b></p> <p>Sales force +</p>	
<p><b>Cost Structure</b></p> <p>Labour          Ingredients and processing aids          Water          Cleaning chemicals          Wastewater treatment          Natural gas</p> <p>Packaging          Maintenance of equipment and facilities          Rent          Investment in equipment and infrastructure          Certification          Transportation          Electricity</p>		<p><b>Revenue Streams</b></p> <p>Sales of packaged fruits and vegetable products          Sales of secondary products such as peel and stone to the cosmetic and animal feed industry</p>		





# BM.17

Evaluate the risks



## BM.17 Evaluate the risks

### TIPS & TRICKS

#### EVALUATE FOOD SAFETY RISKS

In the food and drink processing industry, product safety is a key risk specifically associated with food manufacturing. The manufacturing process has to guarantee that the product is safe for human consumption along the distribution chain. Any changes in the operations of a company might affect the food safety. Food safety should therefore be continuously re-evaluated during eco-innovation activities affecting the manufacturing process.



# BM.17 Evaluate the risks

## LEARNING CASE STUDY OF RISK REGISTER

Risk Register for Mango Pulp Company								
Risk code and name	Impact description	Probability (1-3)	Impact (1-3)	Risk score	Mitigation	Contingency	Action date	Action by
Risk 01 Farmers not complying with new farming methods	<ul style="list-style-type: none"> <li>Loss of reputation and trust amongst consumers</li> <li>Loss of supply and revenue</li> </ul>	2	3	6	On site visits and training for farmers	Work with many farmers in order to secure a supply of fruits and vegetables	17/11/14	Operations manager
Risk 02 Inability to obtain desired certification within 4-5 years	<ul style="list-style-type: none"> <li>Harder to penetrate the international market and gain competitive advantage over cheaper products</li> </ul>	2	3	6	Carefully planned certification process with dedicated resources	Continue selling the products without the certification until requirements are met	14/01/15	CEO
Risk 03 Attract educated workforce	<ul style="list-style-type: none"> <li>New business model is dependent on R&amp;D which requires educated workforce. Diversification and waste value addition is not possible without it</li> </ul>	1	3	3	Offering fair payment and benefits and a good career opportunity	Current employees are experienced and could be further educated with the help of external partners to take on the R&D activities	26/03/15	Technology manager
Risk 04 Lack of financial resources	<ul style="list-style-type: none"> <li>Farmers will not be able to switch to sustainable agriculture without access to finance and the company will be able to invest in new technology and R&amp;</li> </ul>	3	3	9	Creating a strong pitch dedicating time for negotiations with financial institution in order to score the best deal	Be prepared with detailed economic documentation beforehand  Contact government to see if they can help	01/04/15	Marketing manager & accountant



## BM.18

Integrate all the evaluations and make the final selection



## BM.18 Integrate all the evaluations and make the final selection

### TIPS & TRICKS

#### ADDITIONAL METRICS

Additional metrics in the *Business Model Evaluation* template can be added to highlight issues specific to a company or a specific food and drink processing industry sector. Important metrics can be based on the KPIs previously defined in areas such as food safety, soil quality, biodiversity, waste generation etc.

### LEARNING CASE STUDY OF BUSINESS MODEL EVALUATION

Three different business models were developed at Mango Pulp Co. during the Set Business Model phase. They were all evaluated and compared to the current model using the *Business Model Evaluation* template. Ultimately, the Cooperative business model, described in the activity BM.4 'Generate business model concepts at the big picture level', was chosen. Even though the implementation effort for this business model is high, it will require the least amount of direct capital investment, which is a key criterion for Mango Pulp Co. Additionally, this business model will most effectively and holistically address the sustainability challenges recognized during the Preliminary and In-depth Assessments. The CEO of the company felt that this was the business model that would successfully lead the company towards reaching the strategic goals. The results of the business model evaluation done for Mango Pulp Co. are shown below.

## BM.18 Integrate all the evaluations and make the final selection

	<b>Metric</b>	<b>Current situation</b>	<b>Cooperative model</b>	<b>Business model 2</b>	<b>Business model 3</b>
<b>Benefits</b>	<i>Energy intensity</i>	2	3	3	2
	<i>Material and water intensity</i>	2	4	3	4
	<i>Waste generation</i>	2	5	3	3
	<i>Food safety</i>	2	4	3	3
	<i>Soil quality</i>	2	5	3	3
	<i>Human health and toxicity</i>	2	3	3	3
	<i>Job creation and security</i>	2	4	4	3
	<i>Other social issues (e.g. gender equality)</i>	2	4	4	5
	<i>Profitability</i>	2	3	4	2
<b>Risks</b>	<i>Long term risk (after mitigation actions and successful implementation)</i>	2	4	3	3
	<i>Implementation risk (High/Medium/Low)</i>	(None)	Medium	Medium	Low
<b>Costs</b>	<i>Upfront capital investment (state cost estimate)</i>	(None)	Low	High	Medium
	<i>Implementation effort (High/Medium/Low)</i>	(None)	High	Medium	High





# BUILD ROADMAP

Defining a new business model  
to deliver the business strategy



# BR.1

Prepare for the  
roadmapping  
workshop

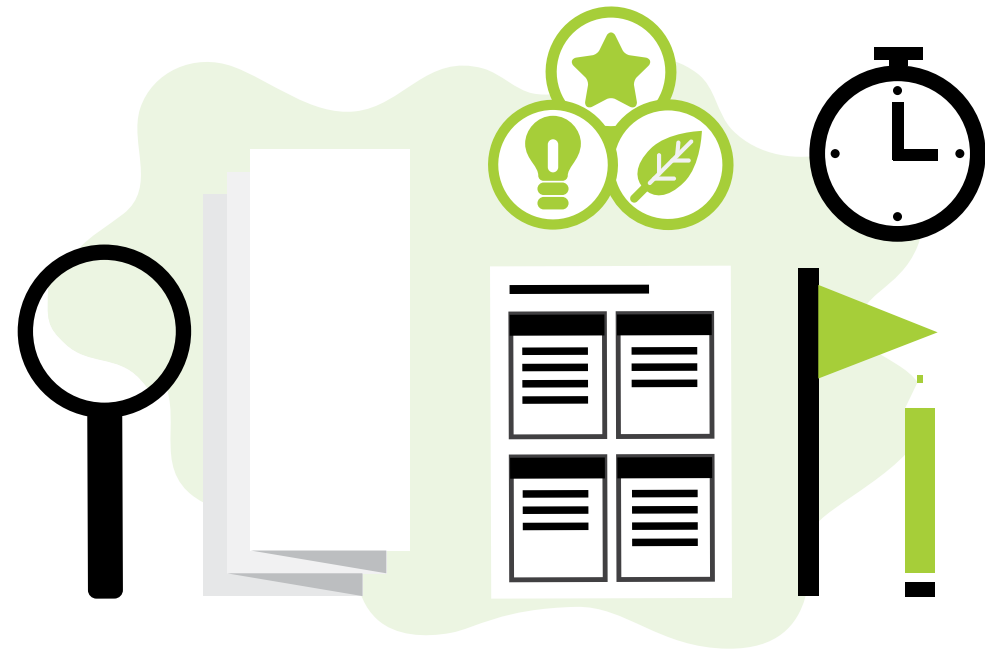

# BR.1 Prepare for the roadmapping workshop

## TIPS & TRICKS

### IDENTIFY QUALITY ASSURANCE REQUIREMENTS AND FACTORS TO PROMOTE MARKET ACCEPTANCE OF NEW PRODUCT OFFERINGS

Think about the quality assurance requirements that are required or valued by existing and future customers.

- What factors could prevent acceptance of the product? What are the trade-offs or negative consequences? (e.g. taste, appearance, texture, shelf-life, etc.)
- How must you adjust or change your existing marketing, sales, and purchasing structure to account for this?
- What factors might have an effect on food safety? Are any trade-offs

acceptable? Remember that food safety is regulated by law, a food company should be very reluctant to accept any trade-offs in this field.

### CONSIDER AND MANAGE UNEXPECTED IMPACTS FROM THE NEW PRODUCT OFFERINGS

Consider if there could be any unexpected impacts from the planned innovation e.g. a significant increase in energy consumption. For instance dried fruits are healthier snacks with long shelf-life, but require significantly more energy for processing compared to fresh fruits. Be sure to investigate such impacts and integrate measures to address them in the roadmap.

### IDENTIFY EXPERTISE REQUIRED TO DEVELOP AND EXECUTE THE NEW BUSINESS MODEL

Consider what expertise is available in-house and what is required:

- Is outside expertise required for product development? Can universities, technical institutes, suppliers, and customers support product development?
- Do you have sufficient R&D and production capacity and budget to perform the necessary steps and tasks? What can you do in-house and what should or could be subcontracted?

### IDENTIFY TESTING REQUIREMENTS FOR NEW PRODUCT OFFERINGS

Consider what the main steps will be to commercialize new product offerings:

- What tests are required? What analytical equipment is required? N.B. It is common to manufacture a new product on a small scale and release it for a test market to study consumer acceptance. Alternatively, consumer panels are often used in pre-commercialization activities.
- What are the costs involved and what time frame is feasible?

### UPDATE KPIS TO MEASURE SUSTAINABILITY PERFORMANCE

A significant change in business model may mean that you need to update the KPIs previously defined in the activity BM.3 'Gather additional data on operational performance'. This should help you to measure and monitor the environmental, social, and economic impact of the new business model. Consider the information or data that is required to properly calculate the KPIs and ensure their availability and accuracy.

# BR.1 Prepare for the roadmapping workshop

## LEARNING CASE STUDY OF ROADMAP DEVELOPMENT MATRIX

This section will guide you through the roadmapping workshop activity using Mango Pulp Co. as an example. The template shows the

key activities the company has to implement in order to transition to the new sustainable business model.

Innovation idea title	Benefits	Capital costs [US\$]	Implementation effort [Person Months, PM]	Implementation risk (High/Medium/Low)	Scheduling considerations
<p>Switch to out-grower schemes</p> <ul style="list-style-type: none"> <li>• Selection of suitable cultivars</li> <li>• Training</li> </ul>	<p>Secure a stable supply of raw materials through long term supply agreement with farmers</p> <p>Provide a secure market for small-holder farmers</p> <p>Increased collaboration with farmers</p>	Low	15 person months (spread over 30 months)	High	Good starting point for eco-innovation as many eco-innovation projects will depend on this large organisational change
<p>Provide extension services to farmers</p> <ul style="list-style-type: none"> <li>• Integrated pest control</li> <li>• Overall improved orchard management</li> </ul>	<p>Secure revenue from providing the service to the farmers as well as increased agricultural production yields and quality</p>	Low	12 person months (spread over 48 months)	Medium	Out-grower schemes need to be implemented
<p>Acquire organic label</p> <ul style="list-style-type: none"> <li>• Find alternative solution to calcium carbide for ripening</li> <li>• Alternative purchasing policies to make sure all ingredients are organic</li> </ul>	<p>Access new markets for sustainably sourced products through organic label</p> <p>Gain a competitive advantage and possibly be able to charge a higher price for their products. Increase overall revenues as a result</p>	Medium	12 person months (spread over 36 months)	Medium	Out-grower schemes need to be implemented

## BR.1 Prepare for the roadmapping workshop

Innovation idea title	Benefits	Capital costs [US\$]	Implementation effort [Person Months, PM]	Implementation risk (High/Medium/Low)	Scheduling considerations
<i>Optimise the value chain operational performance through measurement of key performance indicators</i>	<i>Immediate saving through identification of waste (time, material, labour) in all value chain steps and improving:</i> <ul style="list-style-type: none"> <li>• Process cycle efficiency</li> <li>• Material cycle efficiency</li> <li>• Overall equipment efficiency</li> </ul>	<i>Medium</i>	<i>6 person months</i>	<i>Low</i>	<i>None</i>
<i>Develop a new product</i>	<i>Through diversification and new product development Mango Pulp Co. will have an opportunity to place products on new markets such as markets for dried or frozen fruits and vegetables, healthy bars etc</i>	<i>High</i>	<i>12 person months</i>	<i>Medium</i>	<i>Out-grower schemes need to be implemented</i>
<i>Valorise by-products and reduce losses within the facility</i>	<i>Immediate saving through reduction of waste disposal costs as well as sales of valorised by- and waste products</i>	<i>Medium</i>	<i>6 person months (spread over 18 months)</i>	<i>Low</i>	<i>None</i>
<i>Develop plan for marketing of sustainable products</i>	<i>Creating consumer awareness of the Mango Pulp brand in order to gain a higher market share in the market for sustainably sourced fruit and vegetable products</i>	<i>High</i>	<i>6 person months</i>	<i>Medium</i>	<i>Organic label needs to be acquired</i>

\*Low/medium/high investment costs are specific to Mango Pulp Co.

## BR.2

Do a roadmapping workshop with input from value chain partners

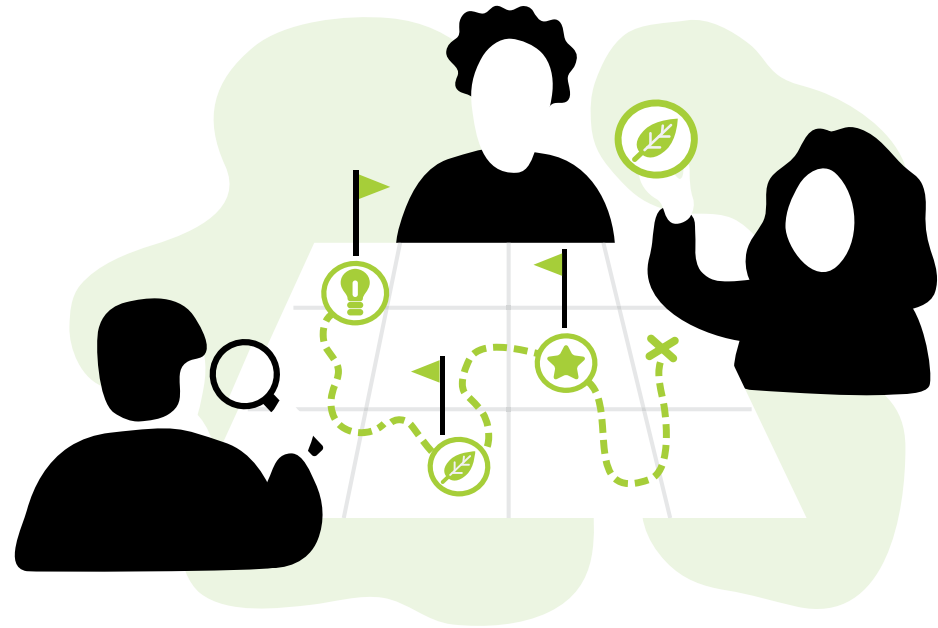

# BR.2 Do a roadmapping workshop with input from value chain partners

## LEARNING CASE STUDY OF ROADMAP

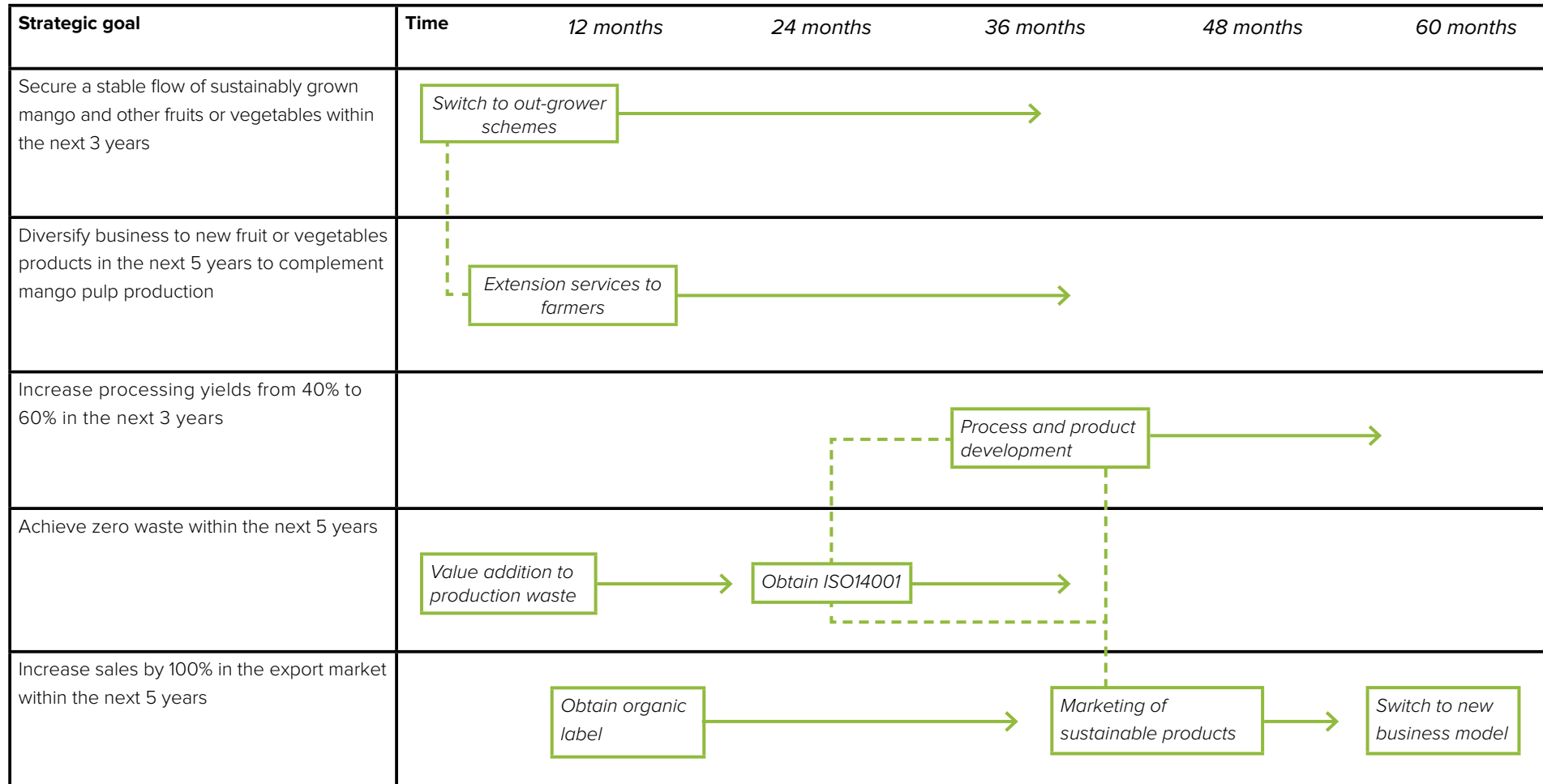



## BR.3

Define and prioritise the requirements of the first project



## BR.3 Define and prioritise the requirements of the first project

### TIPS & TRICKS

#### **START WITH A PROJECT THAT OFFERS LOW IMPLEMENTATION EFFORT AND HIGH IMPACT**

Below you will find an example of a Kenyan tea manufacturer that set strategic goals of improving their position on the international tea market as well as their sustainability performance. To achieve these goals the company created a roadmap of projects and activities that could be implemented within 12 months. The case study below highlights the scope and benefits of the first project on the roadmap to achieving their long-term strategic goals.

#### **Industry example 4: Kitumbe Tea Factory (Kenya)**

Declining yields in tea production due to climate change and inefficient processing had left Kitumbe Tea Factory unable to compete in the tea market, which is driven by low prices. Working with the Kenya National Cleaner Production Centre, they developed an eco-innovation roadmap aimed at becoming a strong competitor on the international tea market. An innovative solar powered ropeway transportation system ropeway system was chosen as their first project for eco-innovation. The system has now been implemented and is used to transport the tea from the plantations to the factory. Among the many benefits of the ropeway system was the immediate saving of almost 300,000 USD in only 9 months. By eliminating the need for transportation by truck, the ropeway system has also significantly reduced greenhouse gas emissions linked to transportation and reduced congestion on local roads.

## BR.3 Define and prioritise the requirements of the first project

### LEARNING CASE STUDY OF REQUIREMENTS SPECIFICATION

The technical requirements for projects can be defined using the *Requirements Specification* template. An example is given where the MoSCoW approach was used for prioritization - see the Eco-

innovation Manual for further information. In this example, the goal of the project is helping Mango Pulp Co. to implement an out-grower scheme.

<b>Requirements specification for TipTop Textiles Company</b>					
<b>Reduction and substitution of hazardous wet textile processing chemicals</b>					
<b>Number or code</b>	<b>Requirement</b>	<b>Comments</b>	<b>Priority (MSCW)</b>	<b>Review date (Project Month)</b>	<b>Reviewed / Approved (All Managers)</b>
Req01	Secure funds for farmers during the transitional period	The farmers will need finance for the period between the start of the new arrangement and the first harvest	M	24/02/2015	CEO
Req02	Outreach and recruitment of farmers	Direct personal contact with local farmers is preferable to start with	M	26/03/2015	CEO
Req03	Develop contracting and pricing strategy	The arrangement between Mango Pulp Co. and out-growers is long a term commitment (~ 15 years) - a clear strategy for contracting and pricing is needed	M	01/10/2015	Marketing manager
Req03	Selection of suitable mango cultivars	Mangoes currently grown have poor agricultural yields and are prone to pest and diseases	S	01/10/2015	Operations manager
Req04	Training of farmers in conservational agriculture	Training will be held several times a year and regular problem-solving workshops will be conducted	M	13/04/2015	Operations manager
Req05	Selection of other crops for diversification		S	21/1/2015	CEO
Req06	Development of routines for control of farms	Unannounced, on-site inspections could be conducted to guarantee that the farmers are following sustainable farming practices	S	25/07/2015	Operations manager
Req07	Development of routines for grading and quality control of incoming raw materials	More effort needs to be put into the pre-processing stages as Mango Pulp Co. will procure all crop from out-grower farms	S	14/08/2015	Marketing manager
Req08	Develop channels for procurement and distribution of inputs	Cold transportation or transportation in early morning and evening could be used to minimize post-harvest waste	M	16/11/2015	CEO

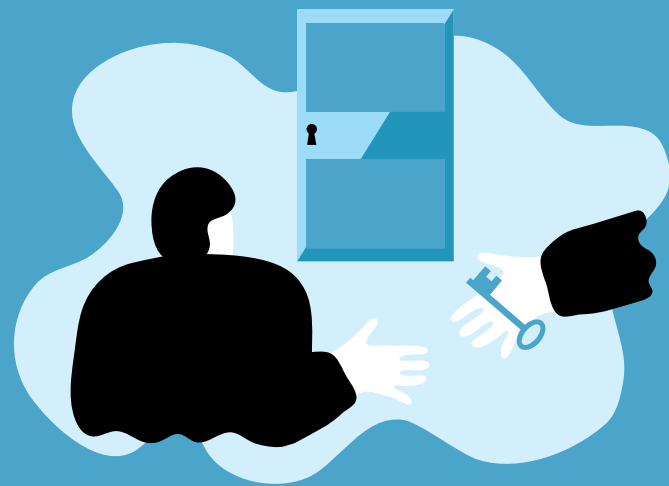

# IMPLEMENT

Implementing the first project for eco-innovation that will help to realise the new business strategy and business model



## IM.3

Provide guidance  
and solve  
problems

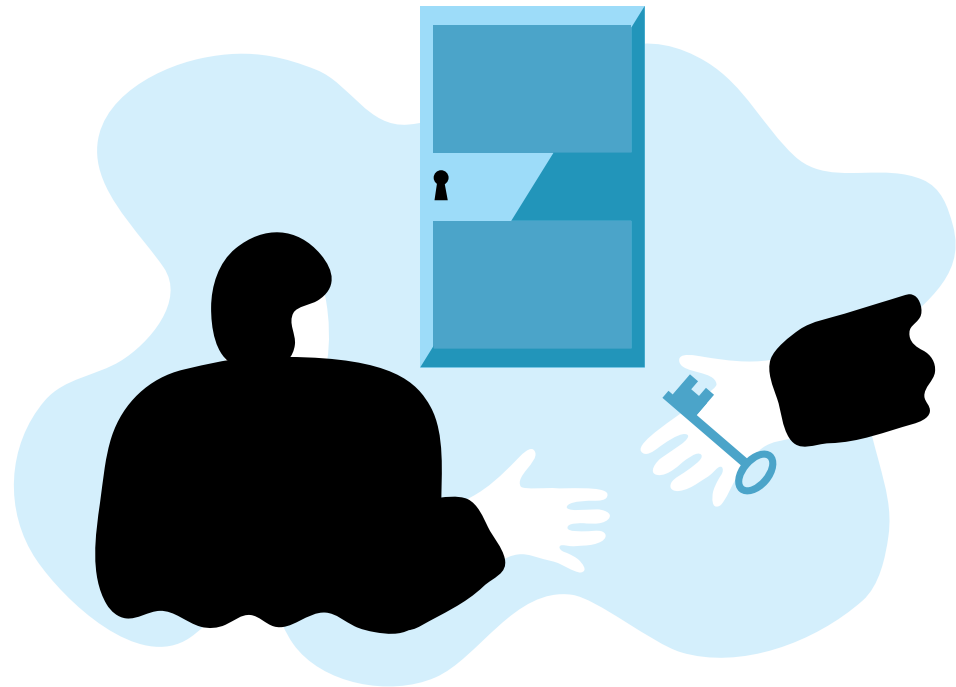

## IM.3 Provide guidance and solve problems

### BACKGROUND INFORMATION

Additional tools may be used to support the COMPANY in implementing specific technical projects in the food industry (e.g. conducting specific audits, developing processes, optimising existing process, or formulating a new products). The following is a list of selected technical tools and resources to support the implementation of eco-innovation project in the food industry:

- UN Environment Publications:
  - Moving Ahead with Technologies for Eco-innovation, 2016, UN Environment
  - Cutting waste... Resource efficiency and eco-innovation for sustainable food chains, 2013, UN Environment
  - Guidelines for social Life Cycle Assessment of products, 2009, UN Environment
- UNIDO/UN Environment Toolkits
  - Cleaner Production Toolkit: <http://www.unido.org/en/resources/publications/energy-and-environment/industrial-energy-efficiency/cp-toolkit-english.html>
  - Responsible Production Toolkit: <http://www.unep.org/responsibleproduction/>
- OECD Sustainable Manufacturing Toolkit. Seven Steps to Environmental Excellence. Start-up Guide. 2011. <http://www.oecd.org/innovation/green/toolkit/48704993.pdf>
- U.S. EPA's The Lean and Environment Toolkit: <http://www.epa.gov/lean/environment/toolkits/environment/resources/LeanEnviroToolkit.pdf>
- WRAP publications and Toolkits found at <http://www.wrap.org.uk/>
  - Self-Assessment Review for Food and Drink Manufacturers: [http://www.wrap.org.uk/sites/files/wrap/WRAP\\_Food\\_Drink\\_Manufacturers.pdf](http://www.wrap.org.uk/sites/files/wrap/WRAP_Food_Drink_Manufacturers.pdf)
  - Waste Prevention Good Practice Guidance: <http://www.wrap.org.uk/sites/files/wrap/Waste%20prevention%20good%20practice%20guidance.pdf>
  - Reducing Food Waste through Retail Supply Chain Collaboration: [http://www.wrap.org.uk/sites/files/wrap/WRAP\\_IGD\\_supply\\_chain\\_report.pdf](http://www.wrap.org.uk/sites/files/wrap/WRAP_IGD_supply_chain_report.pdf)
  - Saving Money Through Resource Efficiency: Reducing Water Use: <http://www.wrap.org.uk/content/saving-money-through-resource-efficiency-reducing-water-use>
  - Tracking Water Use to Cut Costs: <http://www.wrap.org.uk/content/tracking-water-use-cut-costs>
  - Reducing Your Water Consumption: <http://www.wrap.org.uk/content/reducing-your-water-consumption>
  - Finding Cost Savings: Resource Efficiency for SMEs: <http://www.wrap.org.uk/content/finding-cost-savings-resource-efficiency-smes>
  - Resource Efficiency for Managers: <http://www.wrap.org.uk/content/resource-efficiency-managers>
  - Environmental Strategic Review Guide: <http://www.wrap.org.uk/content/environmental-strategic-review-guide>
  - Waste Mapping: Your Route to More Profit: <http://www.wrap.org.uk/content/waste-mapping-your-route-more-profit>
  - Workforce Partnerships for Resource Efficiency: <http://www.wrap.org.uk/content/workforce-partnerships-resource-efficiency>
  - Your Guide to Environmental Management Systems (EMS):



## IM.3 Provide guidance and solve problems

<http://www.wrap.org.uk/content/your-guide-environmental-management-systems-ems>

- WRAP Waste Hierarchy Guide: <http://wastehierarchy.wrap.org.uk/>
- Opportunities for Resource Efficiency in the Food and Drink Sector (2011): <http://www.wrap.org.uk/sites/files/wrap/Opportunities%20for%20resource%20efficiency%20in%20the%20food%20and%20drink%20sector%20FINAL.pdf>
- Lightweighting the Can Pack: <http://www.wrap.org.uk/content/lightweighting-can-pack>
- Lightweighting Carbonated Soft Drinks Bottles: <http://www.wrap.org.uk/content/lightweighting-carbonated-soft-drinks-bottles>
- World Resource Institute publications:
  - Reducing Food Loss and Waste: [http://www.wri.org/sites/default/files/reducing\\_food\\_loss\\_and\\_waste.pdf](http://www.wri.org/sites/default/files/reducing_food_loss_and_waste.pdf)

# Glossary of key terms

## **Business model**

Describes how a company does business. It is the translation of strategic issues, such as strategic positioning and strategic goals into a conceptual model that explicitly states how the business functions. The business model serves as a building plan that allows designing and realizing the business structure and systems that constitute the company's operational and physical form. (Osterwalder et al, 2005).

## **Business strategy**

Describes the long term goals of the company and the markets in which the company will operate (i.e. vision and mission) (adapted from Andrews, 1997).

## **Gender**

Describes the roles, behaviours, activities, and attributes that a given society at a given time considers appropriate for men and women. These attributes, opportunities and relationships are socially constructed and are learned through socialization processes. They are context/time-specific and changeable. (UN Women)

## **Gender discrimination**

Describes any distinction, exclusion or restriction made on the basis of sex which has the effect or purpose of impairing or nullifying the recognition, enjoyment or exercise by women, irrespective of their marital status, on the basis of equality of men and women, of human rights and fundamental freedoms in the political, economic, social, cultural, civil or any other field (Art.1 CEDAW, 1979).

## **Gender equality**

Refers to the equal rights, responsibilities and opportunities of women and men and girls and boys. Equality does not mean that women and men will become the same but that women's and men's rights, responsibilities and opportunities will not depend on whether they are born male or female. Gender equality implies that the interests, needs and priorities of both women and men are taken into consideration, recognizing the diversity of different groups of women and men. Gender equality is not a women's issue but should concern and fully engage men as well as women. (UN Women)

## **Gender-sensitive**

Describes an attempt to redress existing gender inequalities when designing and implement development projects, programs or policies.

## **Life cycle**

Consecutive and interlinked stages of a product (good or service), from the extraction of natural resources to the final disposal (adapted from ISO 14040:2006).

## **Life cycle assessment**

It is a systematic set of procedures for compiling and examining the inputs and outputs of materials and energy and the associated environmental impacts directly attributable to the functioning of a product throughout its life cycle (adapted from ISO 14040:2006).

## **Life cycle thinking**

It is a mostly qualitative approach to understand how our choices influence what happens at each of the stages of the life cycle of an industrial activity: from raw material acquisition through manufacture, distribution, product use and disposal. This approach is needed in order for us to balance trade-offs and positively impact the economy, the environment, and society (UN Environment, 2004).

# Glossary of key terms

## **Marketing**

It is the set of activities that are designed to help the company to understand the type of product it should offer to a market and communicate the benefits and value of the product to the targeted consumer. Marketing focuses on the product, promotion, price and distribution channels.

## **Market analysis**

It is the activity of gathering information about the size, growth, profitability, target groups and existing products of a market, which is used to inform decision making at a strategic level. This specific activity would fall under the broader umbrella of marketing activities.

## **Organization structure**

It refers to the range of activities and key resources (human and financial) within the company, in addition to those relating directly to production, that are dedicated to supporting the business model. These include procurement processes, distribution, key partnerships, customer relationships and interfaces, research and development, internal communication, and revenue generation.

## **Partners**

It refers to parties in the value chain that provide or receive value including suppliers, outsourced workers, contractors, customers, consumers, clients, members, and others (ISO 26000:2010).

## **Roadmap**

It is a planning tool used to support the implementation of strategies. It is made-up of a series of projects that will help to progress the organization from the company's current position towards fulfilling the organization's goals (adapted from Phaal R et al, 2007).

## **Stakeholder**

It is any group or individual who can affect, or is affected by, an organization or its activities. Also, any individual or group that can help define value propositions for the organization (Stakeholder Research Associates Canada Inc., United Nations Environment Programme, AccountAbility: Stakeholder Engagement, 2005).

## **Supply chain**

It is a system of organizations, technology, activities, information and resources involved in moving a product or service from supplier to customer (Michael Porter 1985) are the most significant impacts in the value chain or the life cycle of a product or service system, which can be used to identify impact improvement opportunities and to prioritize impact reduction actions (UN Environment/SETAC, 2014).

## **Value**

It is understood to involve creating economic value (the revenue that a firm gets in return for its goods or services) in a way that also creates positive Outputs for society by addressing its needs and threats, taking into account economic, environmental and social considerations (adapted from Porter & Kramer, 2011).

## **Value chain**

It is the entire sequence of activities or parties that provide or receive value in the form of products or services (e.g. suppliers, outsource workers, contractors, investors, R&D, customers, consumers, members) (ISO 14001 CD2, 2013). See also Partners definition above.

## **Value proposition**

It refers to the products or services that an organization offers to a specific market segment that the organization believes will create value for that specific market segment.

# List of Figures, Tables and Industry Examples

## **Figures**

Figure 1. Overview of the agri-food sector structure	<b>PR1</b>
Figure 2. Generic food value chain	<b>PR1</b>
Figure 3. shows a detailed agri-food value chain including the flows of all important inputs and outputs. This is still a general representation, as different markets will have different value chains.	<b>PR1</b>
Figure 4. Greenhouse gas emission from selected food products (Environmental Working Group, 2011)	<b>PR1</b>
Figure 5. Environmental sustainability impact of different stages of the agri-food value chain (UN Environment, 2016)	<b>PR4</b>
Figure 6. Food loss and waste across the agri-food value chain (Lipinski, 2013)	<b>PR4</b>
Figure 7. Schematic representation of the life cycle of canned mango pulp	<b>PR4</b>
Figure 8. Generic process flow chart for a typical food and drink manufacturing process (WRAP, 2013)	<b>ST4</b>
Figure 9. Current operations of Mango Pulp Co.	<b>ST4</b>
Figure 10. Example of social indicators in the agri-food value chain (Agresearch, 2009)	<b>BM3</b>
Figure 11. Key partners in achieving a sustainable business model.	<b>BM4</b>

## **Tables**

Table 1. Reasons why food processed and its intended benefits (Adapted from Teaching the Food System, n.d.)	<b>PR1</b>
Table 2. List of examples of funding schemes available for eco-innovative SMEs (UNIDO, 2009)	<b>PR3</b>
Table 3. Trends directly influencing the agri-food value chain (Accenture, 2011)	<b>PR5</b>
Table 4. Business models used in the food and drink processing industry.	<b>ST3</b>
Table 5. Sustainability hotspots for Mango Pulp Company and ideas how stakeholder could help to address them.	<b>ST6</b>
Table 6. Commonly used operational KPIs in the food industry (WRAP, 2013)	<b>BM3</b>
Table 7. Percentage of raw materials (by weight), which end up in the final product in selected processes (European Commission, 2006)	<b>BM3</b>

# List of Figures, Tables and Industry Examples

## **Industry examples**

Industry example 1: HWP Fresh and Dry Ltd

Industry example 2: PacMoore Products, Inc

Industry example 3: Upland Rice Millers – Uganda

Industry example 4: Kitumbe Tea Factory (Kenya)

## **Image credits**

**ST9**

All images unless the ones stated below are property of UN Environment and licenced under Creative Commons BY 4.0.

**BM10**

Page 12 [www.flickr.com/photos/dvortygirl/2445114424](http://www.flickr.com/photos/dvortygirl/2445114424)

Page 22 [www.flickr.com/photos/103874658@N03/](http://www.flickr.com/photos/103874658@N03/)

Page 46 [www.flickr.com/photos/bestorg/8733059592](http://www.flickr.com/photos/bestorg/8733059592)

**BM10**

Page 70 [www.flickr.com/photos/kerolic/8255650653](http://www.flickr.com/photos/kerolic/8255650653)

Page 81 [www.flickr.com/photos/jwyg/4271384931](http://www.flickr.com/photos/jwyg/4271384931)

Page 82 [www.flickr.com/photos/theonecampaign/12757535544](http://www.flickr.com/photos/theonecampaign/12757535544)

Page 87 [www.flickr.com/photos/cambodia4kidsorg/7197338286](http://www.flickr.com/photos/cambodia4kidsorg/7197338286)

Page 90 [www.flickr.com/photos/jtanenbaum/15675605933](http://www.flickr.com/photos/jtanenbaum/15675605933)

Page 104 [www.flickr.com/photos/9880707@N02/3311300060](http://www.flickr.com/photos/9880707@N02/3311300060)

Page 112 [www.flickr.com/photos/gruenenrw/8569486276](http://www.flickr.com/photos/gruenenrw/8569486276)

Page 115 [www.flickr.com/photos/deusto/8391208619](http://www.flickr.com/photos/deusto/8391208619)

Page 116 [www.flickr.com/photos/undpeuropeandcis/6188461478](http://www.flickr.com/photos/undpeuropeandcis/6188461478)

Page 124 [www.flickr.com/photos/deusto/8392295196](http://www.flickr.com/photos/deusto/8392295196)

Page 127 [www.flickr.com/photos/cambodia4kidsorg/7197381814](http://www.flickr.com/photos/cambodia4kidsorg/7197381814)

Page 128 [www.flickr.com/photos/gruenenrw/8417210388](http://www.flickr.com/photos/gruenenrw/8417210388)

Page 136 [www.flickr.com/photos/kristiand/3223920178](http://www.flickr.com/photos/kristiand/3223920178)

Page 138 [www.flickr.com/photos/jzawodn/6495653](http://www.flickr.com/photos/jzawodn/6495653)

Page 140 [www.flickr.com/photos/cgiarclimate/7164244002](http://www.flickr.com/photos/cgiarclimate/7164244002)

Page 158 [www.flickr.com/photos/esqbs/9576136788](http://www.flickr.com/photos/esqbs/9576136788)



**United Nations Environment Programme**  
P.O. Box 30552, Nairobi 00100, Kenya  
**Tel:** +254-(0)20-762 1234  
**Fax:** +254-(0)20-762 3927  
**Email:** [unep@unep.org](mailto:unep@unep.org)  
**Web:** [www.unep.org](http://www.unep.org)

